

# JVC



SEE  
AUTO SET UP  
ON REAR SIDE

## VIDEO CASSETTE RECORDER

## ENGLISH

HR-J648EH (Hi-Fi)  
HR-J648E (Hi-Fi)  
HR-J448E (Monaural)  
HR-J248E (Monaural)

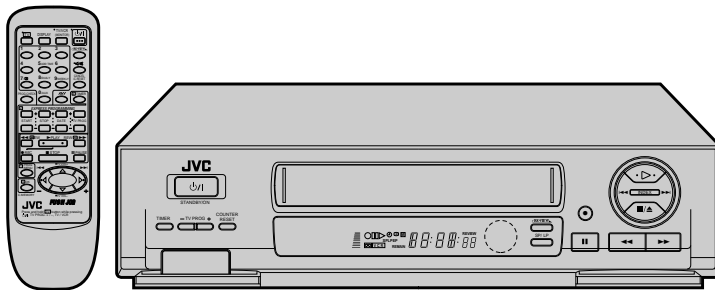

The recorder illustrations appearing in this instruction manual are of the HR-J648E.

**SHOWVIEW** *Hi-Fi* **VHS**  
PAL

## INSTRUCTIONS

### CONTENTS

<b>SAFETY FIRST</b>	<b>2</b>
Safety Precautions .....	2
<b>INSTALLING YOUR NEW RECORDER</b>	<b>3</b>
Basic Connections .....	3
<b>INITIAL SETTINGS</b>	<b>4</b>
Auto Set Up .....	4
Language .....	7
Video Channel Set .....	8
SHOWVIEW Setup .....	10
<b>PLAYBACK</b>	<b>12</b>
Basic Playback .....	12
Playback Features .....	13
<b>RECORDING</b>	<b>17</b>
Basic Recording .....	17
B.E.S.T. Picture System .....	18
On-Screen Displays .....	20
Recording Features .....	21
<b>TIMER RECORDING</b>	<b>24</b>
SHOWVIEW Timer Recording .....	24
Regular Timer Programming .....	26
<b>EDITING</b>	<b>30</b>
Edit To Or From Another Video Recorder .....	30
Edit From A Camcorder .....	32
<b>SYSTEM CONNECTIONS</b>	<b>33</b>
Connecting/Using A Decoder ...	33
<b>TUNER SET</b>	<b>34</b>
<b>CLOCK SET</b>	<b>39</b>
<b>QUESTIONS AND ANSWERS</b>	<b>41</b>
<b>TROUBLESHOOTING</b>	<b>42</b>
<b>INDEX</b>	<b>44</b>
<b>SPECIFICATIONS</b>	<b>47</b>

# Safety Precautions

The rating plate and the safety caution are on the rear of the unit.

**WARNING: DANGEROUS VOLTAGE INSIDE**

**WARNING: TO PREVENT FIRE OR SHOCK HAZARD, DO NOT EXPOSE THIS UNIT TO RAIN OR MOISTURE.**

## CAUTION

- When you are not using the recorder for a long period of time, it is recommended that you disconnect the power cord from the mains outlet.
- Dangerous voltage inside. Refer internal servicing to qualified service personnel. To prevent electric shock or fire hazard, remove the power cord from the mains outlet prior to connecting or disconnecting any signal lead or aerial.

## WARNING

There are two different types of SECAM colour systems: SECAM-L, used in FRANCE (also called SECAM-West), and SECAM-B, used in Eastern European countries (also called SECAM-East).

1. This recorder can also receive SECAM-B colour television signals for recording and playback.
2. Recordings made of SECAM-B television signals produce monochrome pictures if played back on a video recorder of SECAM-L standard, or do not produce normal colour pictures if played back on a PAL video recorder with SECAM-B system incorporated (even if the TV set is SECAM-compatible).
3. SECAM-L prerecorded cassettes or recordings made with a SECAM-L video recorder produce monochrome pictures when played back with this recorder.
4. This recorder cannot be used for the SECAM-L standard. Use a SECAM-L recorder to record SECAM-L signals.

## For Italy:

"It is declared that this product, brand JVC, conforms to the Ministry Decree n. 548 of 28 Aug. '95 published in the Official Gazette of the Italian Republic n. 301 of 28 Dec. '95"



- Only cassettes marked "VHS" can be used with this videorecorder.
- HQ VHS is compatible with existing VHS equipment.
- SHOWVIEW is a registered trademark of Gemstar Development Corporation. The SHOWVIEW system is manufactured under licence from Gemstar Development Corporation.

## IMPORTANT

- Please read the various precautions on this page before installing or operating the recorder.
- It should be noted that it may be unlawful to re-record pre-recorded tapes, records, or discs without the consent of the owner of copyright in the sound or video recording, broadcast or cable programme and in any literary, dramatic, musical, or artistic work embodied therein.

The STANDBY/ON  $\phi$ /I button does not completely shut off mains power from the unit, but switches operating current on and off. " $\phi$ " shows electrical power standby and "I" shows ON.

## To HR-J648E/J648EH/J448E Owners:

Video tapes recorded with this video recorder in the LP (Long Play) mode cannot be played back on a single-speed video recorder.

**Failure to heed the following precautions may result in damage to the recorder, remote control or video cassette.**

1. **DO NOT** place the recorder . . .
  - ... in an environment prone to extreme temperatures or humidity.
  - ... in direct sunlight.
  - ... in a dusty environment.
  - ... in an environment where strong magnetic fields are generated.
  - ... on a surface that is unstable or subject to vibration.
2. **DO NOT** block the recorder's ventilation openings.
3. **DO NOT** place heavy objects on the recorder or remote control.
4. **DO NOT** place anything which might spill on top of the recorder or remote control.
5. **AVOID** violent shocks to the recorder during transport.

## MOISTURE CONDENSATION

Moisture in the air will condense on the recorder when you move it from a cold place to a warm place, or under extremely humid conditions—just as water droplets form in the surface of a glass filled with cold liquid. Moisture condensation on the head drum will cause damage to the tape. In conditions where condensation may occur, keep the recorder turned on for a few hours to let the moisture dry.

## ABOUT HEAD CLEANING

Accumulation of dirt and other particles on the video heads may cause the playback picture to become blurred or interrupted. Be sure to contact your nearest JVC dealer if such troubles occur.

# Basic Connections

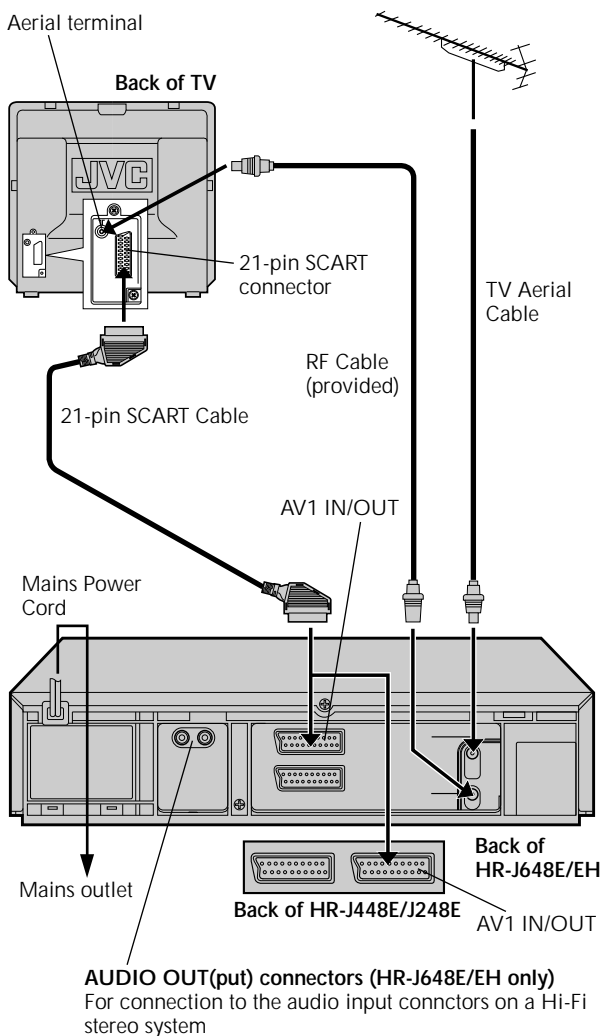

It's essential that your video recorder be properly connected. Follow these steps carefully. THESE STEPS MUST BE COMPLETED BEFORE ANY VIDEO OPERATION CAN BE PERFORMED.

## 1

### CHECK CONTENTS

Make sure the package contains all of the accessories listed in "Specifications" (☞ pg. 47).

## 2

### SITUATE RECORDER

Place the recorder on a stable, horizontal surface.

## 3

### CONNECT RECORDER TO TV

The connection method you use depends on the type of TV you have.

#### RF CONNECTION

- *To Connect To A TV With NO AV Input Terminals . . .*
  - a- Disconnect the TV aerial cable from the TV.
  - b- Connect the TV aerial cable to the ANT. IN jack on the rear panel of the recorder.
  - c- Connect the provided RF cable between the RF OUT jack on the rear panel of the recorder and the TV's aerial terminal.

**Before operating the recorder, make sure the TV's channel is set to the VIDEO channel (☞ pg. 8).**

#### AV CONNECTION

- *To Connect To A TV With AV Input Terminals . . .*
  - a- Connect the aerial, recorder and TV as per "RF CONNECTION".
  - b- Connect an optional SCART cable between the AV1 IN/OUT socket on the rear panel of the recorder and the TV's 21-pin SCART connector.

**Before operating the recorder, make sure the TV is set to the VIDEO (or AV) mode.**

## 4

### CONNECT RECORDER TO MAINS

Plug the end of the mains power cord into a mains outlet.

After you plug the mains power cord into a mains outlet, the Country Set display appears on the TV screen and/or on the recorder's front display panel when the button on the recorder/remote control is pressed for the first time to power on the recorder; go to page 4 to perform Auto Set Up.

# Auto Set Up

## Auto Channel Set/Auto Clock Set/Auto Guide Program Number Set

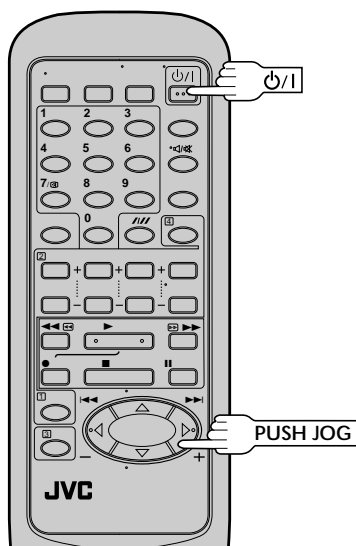
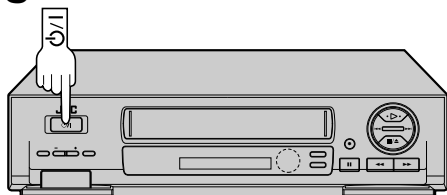

### International Telephone Country Code

SUOMI	: 358	SUISSE	: 41
PORTUGAL	: 351	ITALIA	: 39
DEUTSCHLAND	: 49	ESPAÑA	: 34
NORGE	: 47	BELGIUM	: 32
SVERIGE	: 46	NEDERLAND	: 31
DANMARK	: 45	GREECE	: 30
ÖSTERREICH	: 43	OTHERS	: - -

### ATTENTION

Once you have performed Auto Set Up, even if the recorder's memory backup has expired, all the stored stations and their Guide Program numbers remain in the recorder's memory and the recorder will not perform Auto Set Up again. You only need to set the clock. (pg. 39)

If you have moved to a different area, perform each setting as required.

- Tuner setting (pg. 34)
- Clock setting (pg. 39)
- SHOWVIEW Guide Program number setting (pg. 10)

If a new station starts broadcasting in your area, perform both tuner setting (pg. 34) and SHOWVIEW Guide Program number setting (pg. 10).

When the button on the recorder/remote control is pressed for the first time to power on the recorder after you plug the mains power cord into a mains outlet, the Country Set display will appear on the TV screen and the recorder's front display panel. By simply selecting your country\*, the Auto Set Up function sets the tuner channels, clock and Guide Program numbers automatically.

\* If you live in Belgium or Switzerland, you also need to select the language you use.

You can refer to the front display panel and/or the on-screen display to perform this procedure.

Before starting, make sure of the following:

- The TV aerial cable should be connected to the recorder.
- The recorder's mains power cord should be connected to a mains outlet. (pg. 3)
- If you want to use the on-screen display, the TV should be set to its AV mode (with AV connection (pg. 3) or UHF channel 36 (with RF connection (pg. 3)).

## TURN ON THE RECORDER

1

Press on the recorder or remote control. The Country Set display appears on the front display panel and/or on the screen.

SUOMI	SUISSE
PORTUGAL	ITALIA
DEUTSCHLAND	ESPAÑA
NORGE	BELGIUM
SVERIGE	NEDERLAND
DANMARK	GREECE
ÖSTERREICH	OTHERS
[▲▼] → [OK] [MENU] : EXIT	



### NOTE:

If you have connected your TV to the recorder with RF connection and the on-screen display appearing on UHF channel 36 looks distorted, perform this procedure referring to the front display panel.

## SELECT COUNTRY

2

### If you are referring to the front display panel

Press **PUSH JOG**▲▼ to select your international telephone country code of your country referring to the chart in the left column.

- If you have selected a country code other than 32 (BELGIUM) or 41 (SUISSE), go to step 4.
- If you have selected 32 (BELGIUM) or 41 (SUISSE), go to step 3.

(Ex.) DEUTSCHLAND is selected



### If you are referring to the on-screen display

Press **PUSH JOG**▲▼ to move the highlight bar (pointer) to your country's name.

- If you have selected a country other than BELGIUM or SUISSE, go to step 4.
- If you have selected BELGIUM or SUISSE, go to step 3.

SUOMI	SUISSE
PORTUGAL	ITALIA
DEUTSCHLAND	ESPAÑA
NORGE	BELGIUM
SVERIGE	NEDERLAND
DANMARK	GREECE
ÖSTERREICH	OTHERS
[▲▼] → [OK] [MENU] : EXIT	

(Ex.) DEUTSCHLAND is selected.

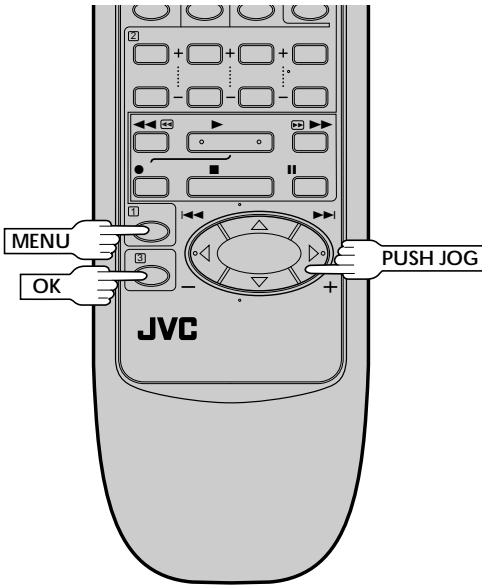

### 3

## SELECT LANGUAGE

Press **OK**. the Language Set display appears on the front display panel and/or on the screen.

### If you are referring to the front display panel

Press **PUSH JOG**  $\Delta \nabla$  to select your language code referring to the chart in the left column.

(Ex.) DEUTSCH is selected for SUISSE

International telephone country code      Language code

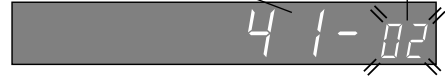

### If you are referring to the on-screen display

Press **PUSH JOG**  $\Delta \nabla$  to move the highlight bar (pointer) to the language of your choice.



(Ex.) DEUTSCH is selected

#### Language Code

ENGLISH : 01	NEDERLANDS : 06
DEUTSCH : 02	SVENSKA : 07
FRANCAIS : 03	NORSK : 08
ITALIANO : 04	SUOMI : 09
CASTELLANO : 05	DANSK : 10

### 4

## PERFORM AUTO SET UP

Press **OK**.

"Auto" appears on the display panel and blinks; do NOT press any button on the recorder or remote control until the display panel shows the current time or "CH1" or "---:--". (Refer to box on lower left of page.)

- Auto channel set function takes place first; it assigns automatically all receivable stations in your area.
- Auto clock set function sets the clock automatically by reading the clock setting data from a station transmitting a PDC signal while auto channel set is being performed.
- During auto channel set, the recorder recognizes each station name of the detected stations and stores them in the recorder's memory, then automatically sets SHOWVIEW assigned Guide Program number for those stations according to the broadcast area.

### NOTE:

In the area where no TV station transmits a PDC signal, the recorder can perform neither auto clock set nor auto Guide Program number set.

### NOTES:

- If you are using the on-screen display, the AUTO SET screen will appear after pressing **OK** in step 4. As Auto Set Up progresses, the "■" mark on the screen moves from left to right.
- If there is a power cut, or if you press **Power** or **MENU** while Auto Set Up is in progress, Auto Set Up will be interrupted; be sure to turn off the recorder power once and try again from step 1.

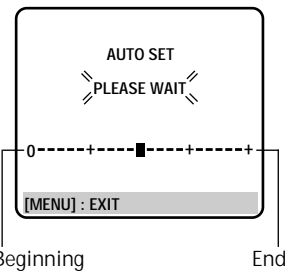

### Auto Set Up results appear on the front display panel

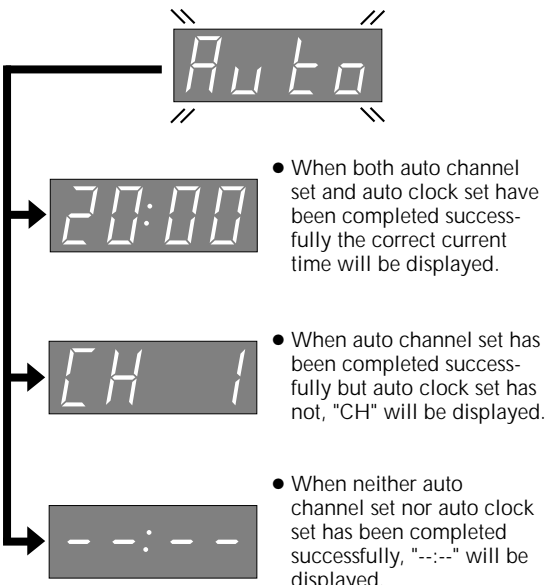

• If Auto Set Up is completed, go to page 6.

**If both auto channel set and auto clock set have been performed successfully:**

- 1 Perform "Video Channel Set" on page 8.
- 2 Turn on the TV and select its VIDEO channel or AV mode, then make sure that all necessary stations have been stored in the recorder's memory by using the **TV PROG.** button(s).
  - If station names (ID —  pg. 38) have also been stored in the recorder's memory, the station name will be displayed at the top left corner of the screen for about 5 seconds when the recorder is tuned to a different station.
  - If you want to set the tuner manually such as to add or skip channels, to change channel positions, or to set or change station names, see pages 36 – 37.
- 3 Perform "SHOWVIEW Setup" on page 10 to check if the Guide Program numbers have been set correctly.



**If auto channel set has succeeded but auto clock set has not:**

- 1 Perform "Video Channel Set" on page 8.
- 2 Turn on the TV and select its VIDEO channel or AV mode, then make sure that all necessary stations have been stored in the recorder's memory by using the **TV PROG.** button(s).
  - If station names (ID —  pg. 38) have also been stored in the recorder's memory, the station name will be displayed at the top left corner of the screen for about 5 seconds when the recorder is tuned to a different station.
  - If you want to set the tuner manually such as to add or skip channels, to change channel positions, or to set or change station names, see pages 36 – 37.
- 3 Perform "Clock Set" on page 39, then "SHOWVIEW Setup" on page 10 to check if the Guide Program numbers have been set correctly.

**If both auto channel set and auto clock set have failed:**

- 1 Make sure the TV aerial cable is connected properly to the recorder and turn off the recorder power once, then turn the recorder power back on again.
  - The Country Set display appears on the front display panel and/or on the screen; perform steps 2 and 4 on pages 4 – 5 again.

**IMPORTANT**

- Depending on the reception conditions, the station names may not be stored correctly, and auto Guide Program Number Set may not work properly. If the Guide Program numbers are not set properly, SHOWVIEW timer recording ( pg. 24) will not work correctly; be sure to check if the Guide Program numbers have been set correctly ( pg. 10, "SHOWVIEW Setup").
- Since your video recorder memorizes all detected stations even if the reception condition is poor, some of those stored stations may produce a noisy picture. To delete those stations,  "Delete A Channel" on page 36.

**INFORMATION****Language for the on-screen display**

Auto Set Up also selects the language automatically for the on-screen display depending on the Country setting you have made in step 2 on page 4 (unless you have selected BELGIUM or SUISSE), as shown below.

SUOMI	→ SUOMI	SVERIGE	→ SVENSKA	ESPAÑA	→ CASTELLANO
PORTUGAL	→ ENGLISH	DANMARK	→ DANSK	NEDERLAND	→ NEDERLANDS
DEUTSCHLAND	→ DEUTSCH	ÖSTERREICH	→ DEUTSCH	GREECE	→ ENGLISH
NORGE	→ NORSK	ITALIA	→ ITALIANO	OTHERS	→ ENGLISH

If you want to change the language setting manually,  "Language" on page 7.

**Just Clock**

Your recorder is equipped with the Just Clock function which provides accurate time keeping through automatic adjustments at regular intervals, by reading data from a PDC signal. If you want to take advantage of this function, simply set it to "ON".

 "Just Clock" on page 39.

# Language

- Be sure to set your Video Channel before performing Language setting (☞ pg. 8).
- Turn on the TV and select the VIDEO channel (or AV mode).

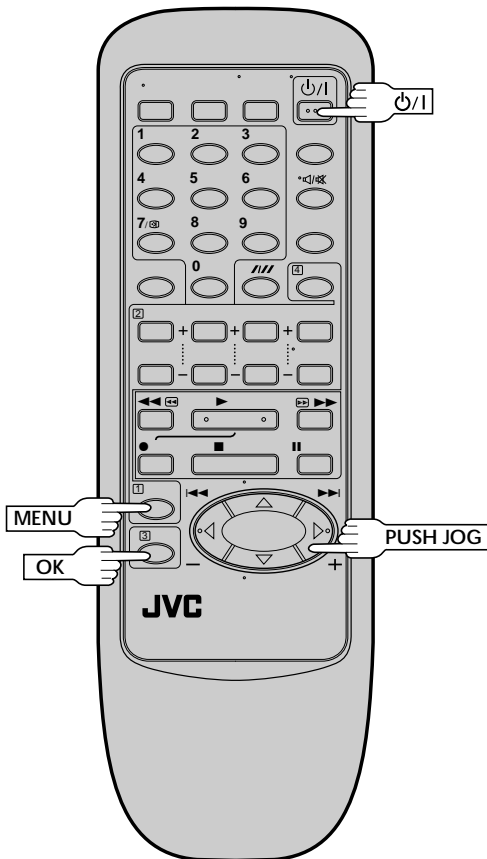

This recorder offers you the choice to view on-screen messages in 10 different languages. Though Auto Set Up selects the language automatically (☞ pg. 6), you can change the language setting manually using this procedure as required.

## 1 TURN ON THE RECORDER

Press **Power/1**.

## 2 ACCESS MAIN MENU

Press **MENU** twice.

## 3 ACCESS COUNTRY SET SCREEN

Press **PUSH JOG** to move the highlight bar (pointer) to "AUTO CH SET", then press **OK**.

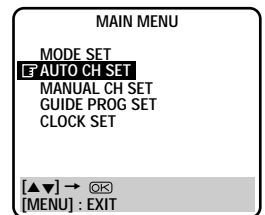

## 4 SELECT COUNTRY

Press **PUSH JOG** to move the highlight bar (pointer) to your country's name, then press **OK**. The Language Set screen appears.

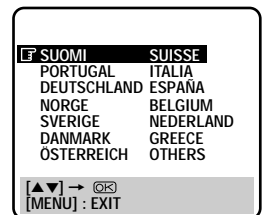

## 5 SELECT LANGUAGE

Press **PUSH JOG** to move the highlight bar (pointer) to the language of your choice.

- You do not have to press **OK**; pressing **OK** starts Auto Channel Set.



## 6 RETURN TO NORMAL SCREEN

Press **MENU**.

# Video Channel Set

Video Channel (RF Output Channel) is the channel on which your TV receives picture and sound signals from the video recorder through the RF cable.

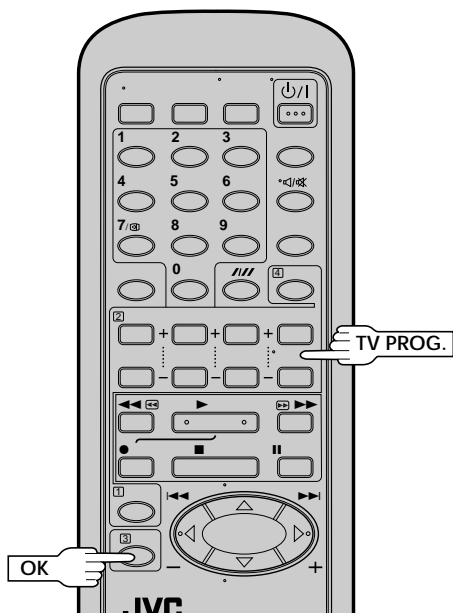
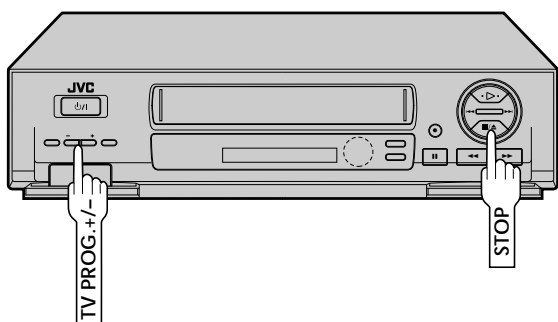

## TEST SIGNAL

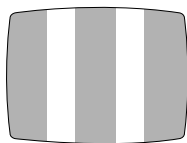

The channel on which the screen to the left appear clearly in step 2 is your Video Channel.

To view picture signals from the video recorder, set your TV to the Video Channel.

If you have connected the video recorder to your TV via the provided RF cable only (RF connection) – Go to "With RF Connection" below.

If you have connected the video recorder to your TV via both the provided RF cable and a 21-pin SCART cable (AV connection) – Go to "With AV Connection" on next page.

## IMPORTANT:

Before performing the following steps, make sure the recorder's power is off and there is no cassette inserted in the recorder.

## With RF Connection

### ACCESS VIDEO CHANNEL SET MODE

Hold down **STOP** on the recorder until the display panel shows the following.



### SET VIDEO CHANNEL

Set your TV to UHF channel 36.

- If the two vertical white bars appear clearly on the screen as shown in the illustration at bottom left, go to step 3.
- If the two vertical white bars do not appear clearly, press **TV PROG.**+ or – to set the video recorder to a vacant channel between 22 and 69 which is not occupied by any local station in your area.

(Ex.) If channel 50 is available in your area



Then set your TV to UHF channel 50 and check if the two vertical white bars appear clearly on the screen; if so, go to step 3. If not, re-set the video recorder to another vacant channel and try again.

## NOTES:

- If you set the video recorder to a channel which is occupied by a local station or has neighbouring channels that are occupied by local stations, the picture reception quality will be affected and some interference noise will appear on the TV screen. Be sure to select a vacant channel which has no broadcast on neighbouring channels.
- If you cannot obtain the two vertical white bars clearly with any channel between 22 and 69, consult your JVC dealer.

### EXIT VIDEO CHANNEL SET MODE

Press **OK**.

# 3

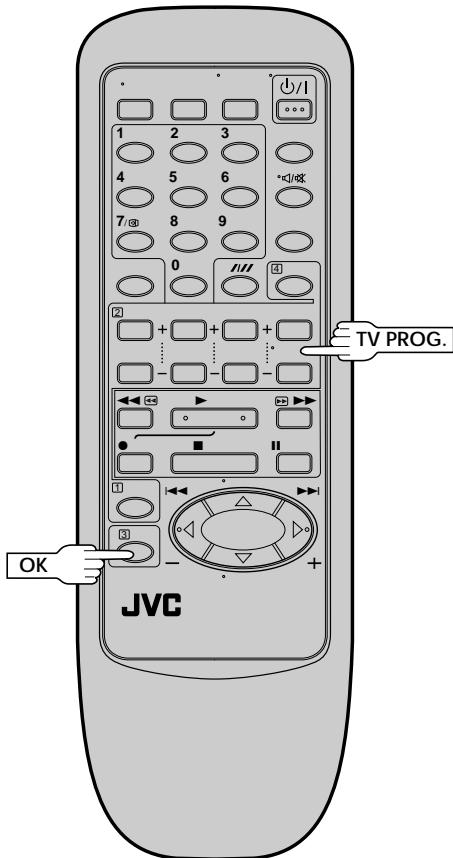
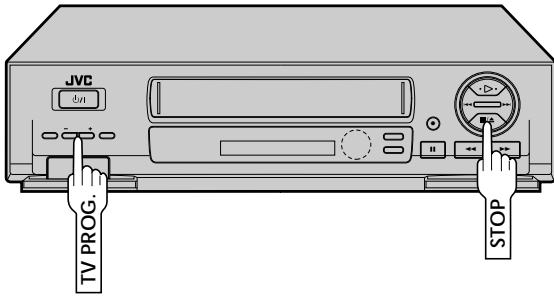

**IMPORTANT:**

Before performing the following steps, make sure the recorder's power is off and there is no cassette inserted in the recorder.

**With AV Connection****ACCESS VIDEO CHANNEL SET MODE****1**

Hold down **STOP** on the recorder until the display panel shows the following.

**SET VIDEO CHANNEL****2**

Press **TV PROG.** until the display panel shows "-OUT--".



- Now the video channel is set to off.

**EXIT VIDEO CHANNEL SET MODE****3**

Press **OK**.

To view picture signals from the video recorder, set your TV to its AV mode.

# SHOWVIEW Setup

Turn on the TV and select the VIDEO channel (or AV mode).

With SHOWVIEW, timer programming is greatly simplified because each TV programme has a corresponding code number which your recorder is able to recognise.

**NOTE:**

"Guide Program (GUIDE PROG) Number" refers to the assigned TV station numbers, according to broadcast area, for SHOWVIEW timer recording.

**IMPORTANT**

Perform the following procedure after Auto Set Up on page 4 and/or the channel setting steps on pages 34 – 37, and after the Clock Set procedure on page 39.

After setting the Guide Program Numbers, the station names and channel positions may be incorrect if you stored or skipped channels. In this case, re-perform Guide Program Number setting.

## Guide Program Number Set

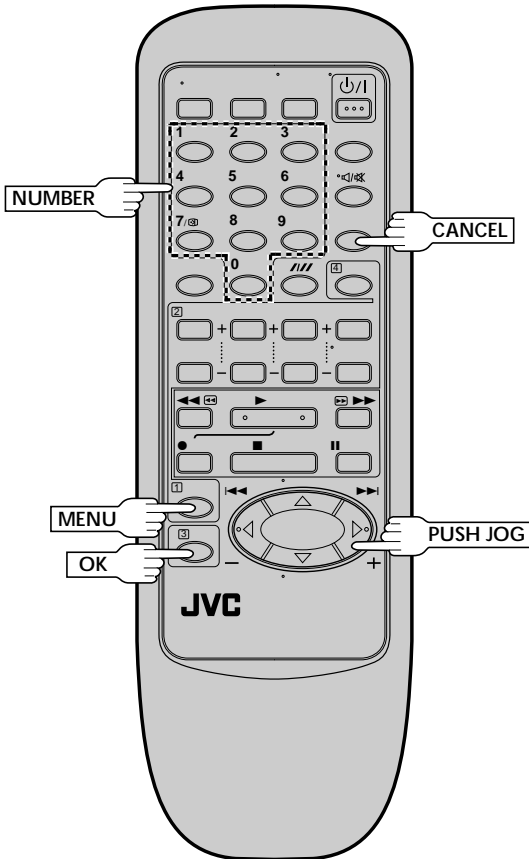

### 1 MAKE LIST OF STORED STATION NAMES AND CHANNEL POSITIONS

(Ex.)

Channel position	Station name
1	ARD
2	ZDF
3	WDR

### 2 ACCESS MAIN MENU SCREEN

Press **MENU** twice.

### 3 ACCESS GUIDE PROG SET SCREEN

Press **PUSH JOG**  $\Delta \nabla$  to move the highlight bar (pointer) to "GUIDE PROG SET", then press **OK**. The Guide Prog. Set screen appears.

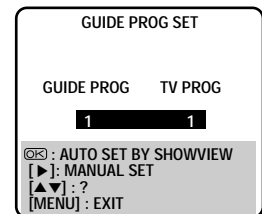
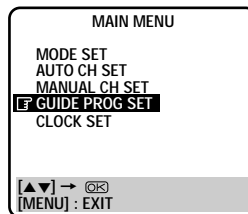

## ENTER SHOWVIEW NUMBER

4

Press **OK**, and a cursor appears above "GUIDE PROG". Then, using the **NUMBER** keys, input the **SHOWVIEW** number (found in most TV listings) of a program scheduled to be broadcast on each station on the list from step 1, starting at the top. If you enter the wrong number, press **CANCEL** to backspace and input the correct number.

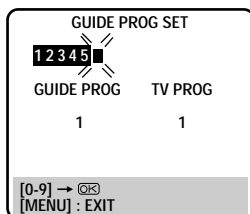

When entering a *SHOWVIEW* number for ZDF

## CONFIRM CHANNEL POSITION NUMBER

5

Press **OK** and the display under "TV PROG" begins blinking.

*If the blinking number under "TV PROG" agrees with the channel position . . .*

. . . press **OK**.

*If the numbers do not agree . . .*

. . . input the channel position using **PUSH JOG**  $\Delta$   $\nabla$  or the **NUMBER** keys, then press **OK**.

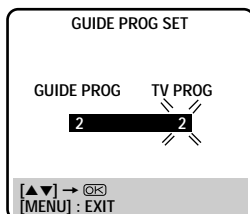

- If you input the **SHOWVIEW** number of a program that has already aired, "ERROR" appears on screen for a few seconds. Input the correct **SHOWVIEW** number.
- Repeat steps 4 and 5 as necessary.

## CLOSE MENU

6

Press **MENU** and selection is complete.

If you already know the Guide Program number for a station . . .

- 1- After step 3, press **PUSH JOG**  $\triangleright$ .
  - The **GUIDE PROG** number begins blinking.
- 2- Enter the Guide Program number using the **NUMBER** keys or **PUSH JOG**  $\Delta$   $\nabla$ , then press **PUSH JOG**  $\triangleright$ .
  - The **TV PROG** number begins blinking.
- 3- Enter the channel position using the **NUMBER** keys or **PUSH JOG**  $\Delta$   $\nabla$ , then press **PUSH JOG**  $\triangleleft$ .
  - Repeat 2 and 3 as necessary.
- 4- Press **MENU**.

## When Using A Satellite Tuner

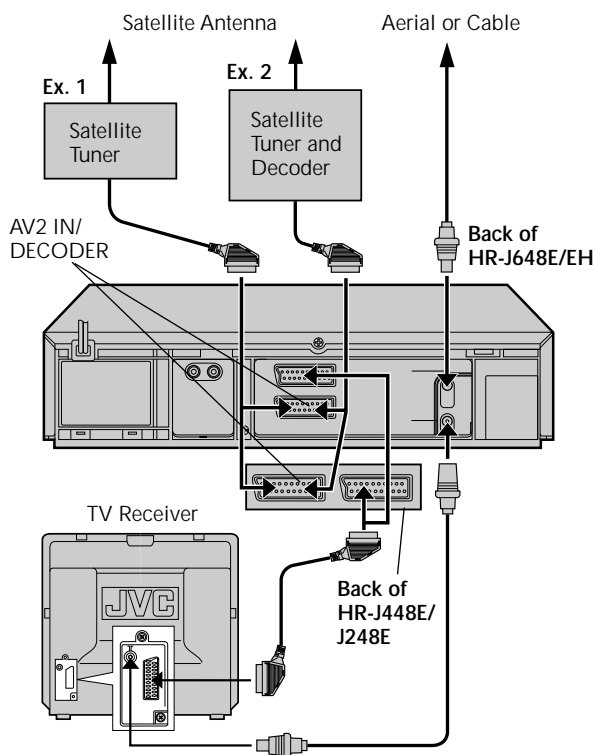

### Preparation

- 1- Connect the satellite tuner to the AV2 IN/DECODER connector on the rear of your recorder.
- 2- Set "AV2 SELECT" to "AV2" (☞ pg. 30).

### To Record Satellite Broadcasts . . .

- 1- Select the appropriate channel on the satellite tuner.
- 2- Press **NUMBER** key "0" to set your recorder's input mode to "AUX2".
- 3- Start recording (☞ pg. 17, steps 3 - 6).

### To Record Satellite Broadcasts Using SHOWVIEW Timer Recording . . .

- 1- Perform Guide Program Number setting.
  - In step 5 in the left column, press **NUMBER** key "0" to set "TV PROG" to "AUX2".
- 2- Perform **SHOWVIEW** Timer Recording (☞ pg. 24).

### To Record Satellite Broadcasts Using Regular Timer Recording . . .

- 1- In step 6 on page 27, press **TV PROG**. +/- to set the channel position to "AUX2".

## NOTE:

When timer-recording a satellite programme, first set the satellite tuner to the appropriate channel before the selected programme begins and then set the satellite tuner's timer. If your satellite tuner does not have a timer, leave it switched on.

# Basic Playback

Turn on the TV and select the VIDEO channel (or AV mode).

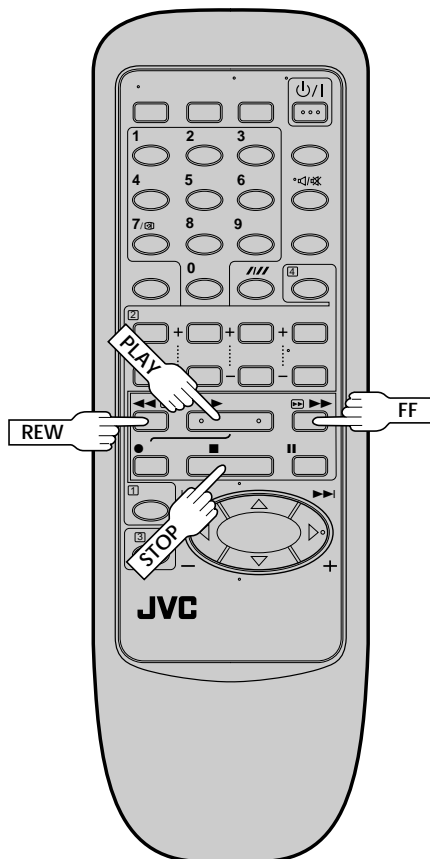
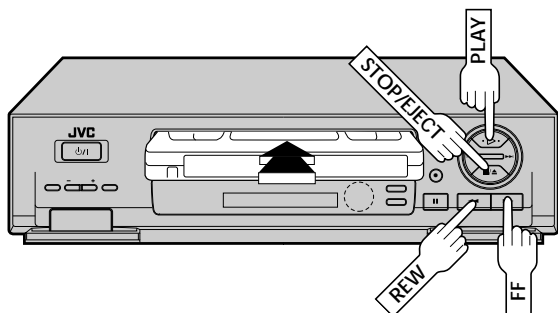

The easiest, most basic operation possible with your video recorder is tape playback. Already-recorded signals on a video tape are read by your video recorder and displayed on your TV just like a TV programme.

1

## LOAD A CASSETTE

Make sure the window side is up, the rear label side is facing you and the arrow on the front of the cassette is point toward the recorder. Don't apply too much pressure when inserting.

- The recorder power comes on automatically and the counter is reset to 0:00:00.
- If the record safety tab has been removed, playback begins automatically.

2

## FIND PROGRAMME START POINT

If the tape is advanced past the start point, press **REW**. To go forward, press **FF**.

3

## START PLAYBACK

Press **PLAY**. "BEST" appears blinking in the recorder's display panel during automatic tracking. (☞ pg. 18)

4

## STOP PLAYBACK

Press **STOP** on the remote or **STOP/EJECT** on the recorder's front panel. Then press **STOP/EJECT** to remove the cassette.

### Usable cassettes

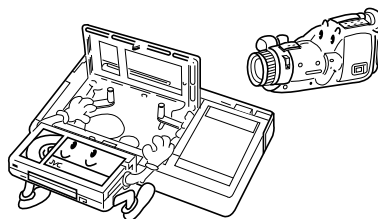

- Compact VHS camcorder recordings can be played on this video recorder. Simply place the recorded cassette into a VHS Cassette Adapter and it can be used just like any full-sized VHS cassette.
- This video recorder can record on regular VHS and Super VHS cassettes. However, it will record and play back regular VHS signals only. It is not possible to play back a recorded Super VHS tape.

# Playback Features

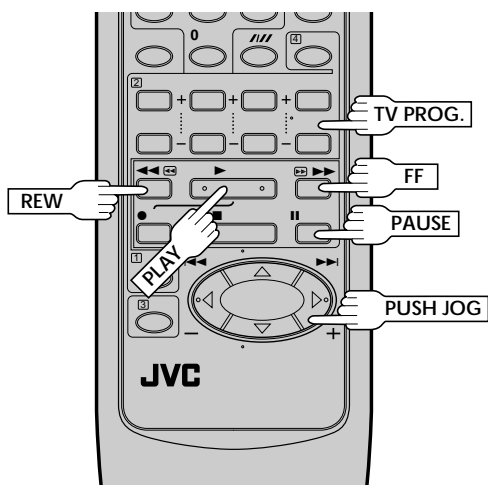
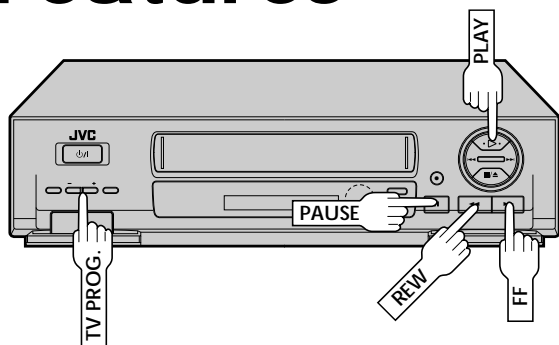

Take advantage of special functions possible with the recorder's controls or the remote control.

## High-Speed Search

### 1 ACTIVATE HIGH-SPEED SEARCH

During playback or still, press **FF** for forward high-speed search, or **REW** for reverse high-speed search.

To resume normal playback, press **PLAY**.

#### NOTES:

- For short searches, press and hold **FF** or **REW** for over 2 seconds. When released, normal playback resumes.
- In the search, still, or frame by frame playback mode, the picture may be distorted, and there may be a loss of colour.

## Still Picture/Frame-By-Frame Playback

### 1 PAUSE DURING PLAYBACK

Press **PAUSE**. If there is vertical jitter, use the **TV PROG.** buttons to correct the picture.

### 2 ACTIVATE FRAME-BY-FRAME PLAYBACK

Press **PAUSE**.

**OR**

Press **PUSH JOG** < or >.

To resume normal playback, press **PLAY**.

## Variable-Speed Search

### 1 ACTIVATE VARIABLE-SPEED SEARCH

During playback, press **PUSH JOG** < or >.

- The more times you press, the faster the playback picture moves.
- To decrease speed, press the button for the opposite direction.

To resume normal playback, press **PLAY**.

#### NOTE:

*In the search, still, or frame by frame playback mode, the picture may be distorted, and there may be a loss of colour.*

## Slow Motion

### 1 ACTIVATE SLOW-MOTION PLAYBACK

During still picture, press and hold **PAUSE** for 2 seconds, then release. Press and release again to return to still picture.

**OR**

During still picture, press and hold **PUSH JOG** < or >. Release to return to still picture.

To resume normal playback, press **PLAY**.

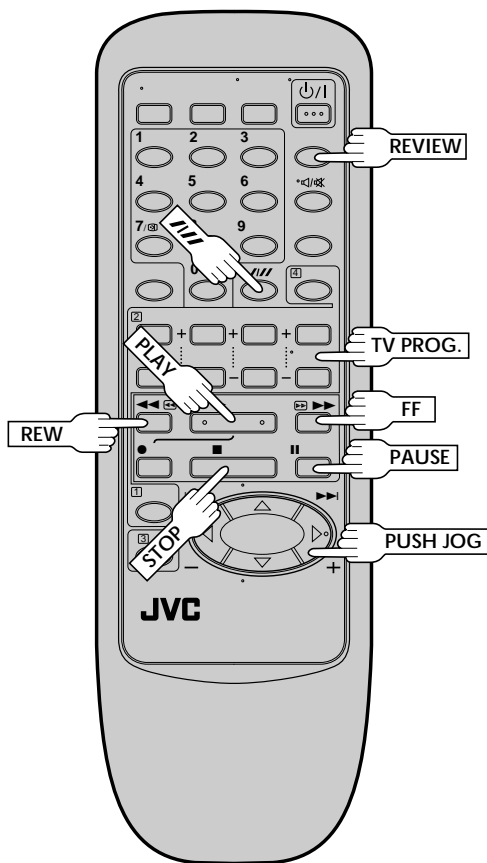
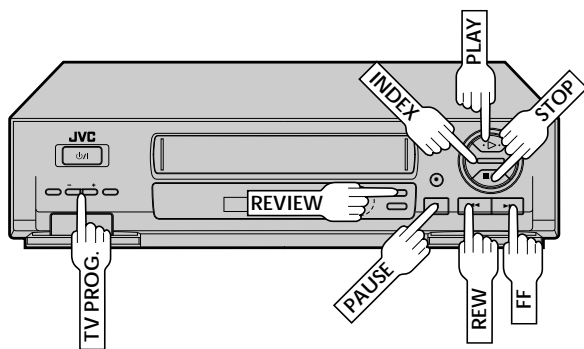

## Manual Tracking

Your video recorder is equipped with automatic tracking control. During playback, you can override this and adjust the tracking manually by pressing the **TV PROG.** buttons.

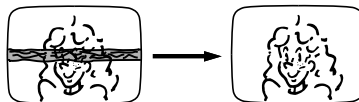

### 1 OVERRIDE AUTOMATIC TRACKING

Press **SP/LP (//)** on the remote to engage manual tracking.

### 2 ADJUST TRACKING MANUALLY

Press **TV PROG. +** or **-** to adjust tracking.

### 3 RETURN TO AUTOMATIC TRACKING

Press **SP/LP (//)** on the remote to re-engage automatic tracking.

#### NOTE:

*When a new tape is inserted, the recorder enters the automatic tracking mode automatically.*

## NTSC Playback

Your video recorder is equipped with NTSC circuitry that can play back NTSC tapes.

### 1 LOAD A CASSETTE

Insert a cassette recorded in NTSC.

### 2 START PLAYBACK

Press **PLAY**.

- "NTSC" appears on the screen for about 5 seconds.
- Some TVs shrink the picture vertically and place black bars at the top and bottom of the screen. This is not a malfunction on the part of either the video recorder or the TV.
- The picture may roll up and down. This can be corrected using the V-HOLD control found on some TVs. (This cannot be corrected if the TV does not have a V-HOLD control.)
- The counter and tape remaining time readings will be incorrect.
- During search, still, or frame-by-frame playback, the picture will be distorted, and there may be a loss of colour.
- Depending on the type of TV, the top and bottom portions of superimposed displays may be cut off during NTSC playback.

## Index Search

Your recorder automatically marks index codes at the beginning of each recording. This function gives you quick access to any one of 9 index codes in either direction.

### NOTE:

Before starting, make sure the recorder is in the Stop mode.



## Repeat Playback

Your video recorder can automatically play back the whole tape 20 times repeatedly.



## START PLAYBACK

Press **PLAY**.

## ACTIVATE REPEAT PLAYBACK

Press **PLAY** and hold for over 5 seconds, then release.

- The Play indicator (▷) on the display panel blinks slowly.
- The tape plays 20 times automatically, and then stops.

## STOP PLAYBACK

Press **STOP** at any time to stop playback.

### NOTE:

Pressing **PLAY**, **REW**, **FF** or **PAUSE** also stops Repeat Playback.

## Information On Colour System

You can also record SECAM signals, or play back a MESECAM tape on this recorder. When a MESECAM tape is played back, "MESECAM" appears on the screen for about 5 seconds. MESECAM is the designation for tapes with SECAM signals that have been recorded on a MESECAM-compatible PAL video recorder.

## Tape Position Indicator

The tape position indicator appears on screen when, from the Stop mode, you press **FF**, **REW** or perform an Index Search. The position of "■" in relation to "0" (beginning) or "+" (end) shows you where you are on the tape.

"O.S.D." (pg. 20) must be set to "ON", or the indicator will not appear.

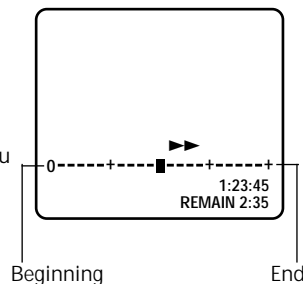

### NOTE:

Depending on the type of tape used, there may be times when the indication is not correct.

1

## ACTIVATE INDEX SEARCH

Press **PUSH JOG** ◀ or ▶ (◀◀◀ or ▶▶▶) on the remote control or **INDEX** ◀◀◀ or ▶▶▶ on the recorder. "◀◀◀ 1" or "▶▶▶ 1" is displayed on screen and search begins in the corresponding direction.

- To access index codes 2 through 9, press **PUSH JOG** ◀ or ▶ or **INDEX** ◀◀◀ or ▶▶▶ repeatedly until the correct index number is displayed.  
Ex.: To locate the beginning of B from the current position, press **PUSH JOG** ◀ or **INDEX** ◀◀◀ twice. To locate the beginning of D from the current position, press **PUSH JOG** ▶ or **INDEX** ▶▶▶ once.

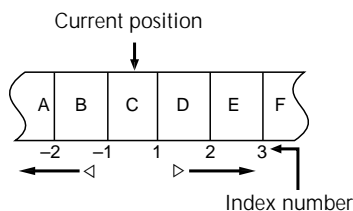

- When the specified index code is located, playback begins automatically.

## Instant ReView

Simply by pressing a single button, the recorder power comes on, rewinds, and begins playback of the last timer-recorded programme. If you have several programmes recorded, you can easily access any of them.

### NOTE:

Before starting, make sure that the recorder is off and that the Timer mode is disengaged.

1

## ACTIVATE INSTANT REVIEW

Press **REVIEW**. The recorder power comes on and the recorder searches for the index code indicating the start of the last timer-recorded programme. Once it's found, playback begins automatically.

The front display panel tells you how many programmes have been recorded. If you have, for example, 3 programmes, "REVIEW" and "3" appear and blink. To watch the first of the 3 programmes, press **REVIEW** three times. The recorder searches and begins playback automatically. You can access a programme as far as 9 index codes away from the current tape position.

### NOTE:

Instant ReView is not possible while the recorder is in the Timer mode.

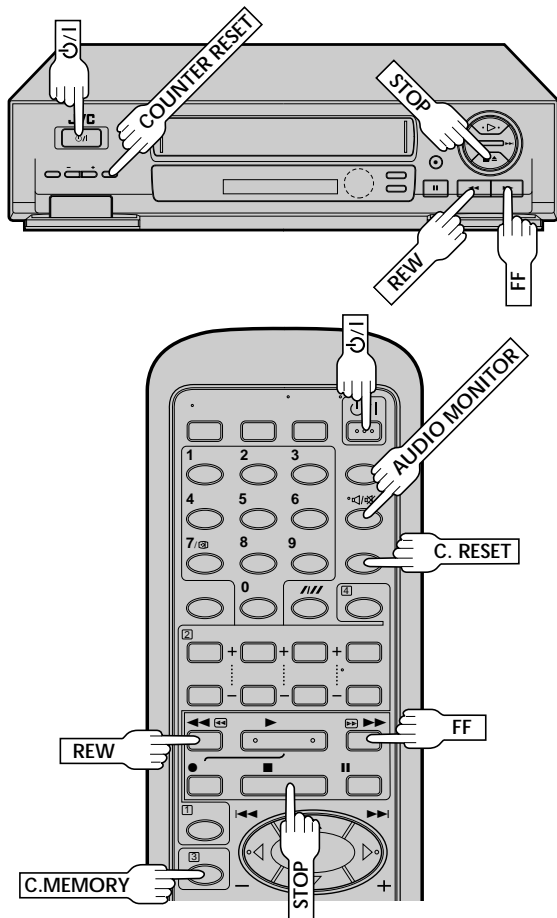

## Next Function Memory

You can set your recorder's power to go off automatically after the tape is fully rewind. Before starting, make sure the recorder is in the Stop mode.  
For Automatic Power Off After Tape Rewind . . .  
. . . press **REW**, then press **⏻** within 2 seconds.

### NOTE:

If you want the power to be turned off automatically when the counter reads "0:00:00" (instead of at the beginning of the tape), press **C.MEMORY** so that the "M" mark appears before pressing **REW**.

## Counter Memory

Returns to the counter reading of "0:00:00" to conveniently find a specific place on the tape automatically.

### 1 SET COUNTER MEMORY

Press **C. (COUNTER) RESET** during playback at a point you wish to locate later. The counter reads "0:00:00". Then press **C.MEMORY**, and "M" appears in front of the counter digits.

### 2 ACTIVATE COUNTER MEMORY

When you wish to return to the designated point, press **STOP** and then **REW** or **FF**.

- The tape rewinds or fast-forwards and stops at about 0:00:00 automatically.
- To cancel Counter Memory, press **C.MEMORY** again.

## Soundtrack Selection (HR-J648E/EH only)

Your video recorder is capable of recording three soundtracks (HI-FI L, HI-FI R and NORM) and will play back the one you select.

### During Playback

Pressing **AUDIO MONITOR** on the remote control changes the soundtrack being played back as follows:

TRACK (On-Screen Display)	USE
HI FI L R	For Hi-Fi stereo tapes
HI FI L	For main audio of Bilingual tapes
HI FI R	For sub audio of Bilingual tapes
NORM	For audio-dubbed tapes
HI FI NORM	For audio-dubbed tapes

### NOTES:

- "L + R" should normally be selected. In this mode, Hi-Fi stereo tapes are played back in stereo, and the normal audio track is played back automatically for tapes with only normal audio.
- For instructions on recording stereo and bilingual programmes, refer to page 22.
- "O.S.D." must be set to "ON" or the on-screen displays will not appear (see pg. 20).



# Basic Recording

Turn on the TV and select the VIDEO channel (or AV mode).

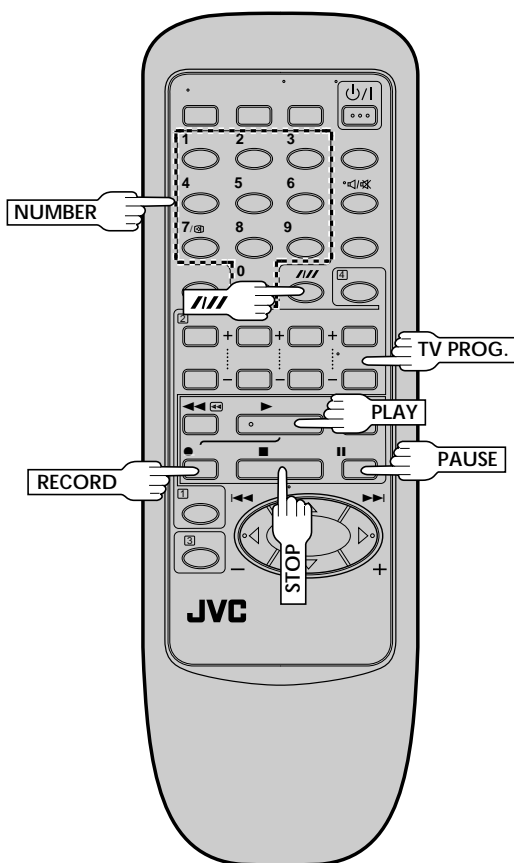
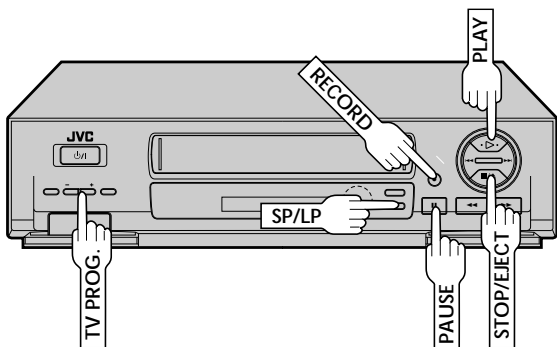

TV signals being received by the recorder's built-in tuner can be recorded onto a video tape. You can "capture" a TV programme using your video recorder.

1

## LOAD A CASSETTE

Insert a cassette with the record safety tab intact.

- The counter is reset to 0:00:00 and the recorder power comes on automatically.

2

## CHOOSE A PROGRAMME

Press **TV PROG. +/-** or the **NUMBER** keys to select the channel you wish to record.

3

## SET TAPE SPEED (HR-J648E/J648EH/J448E ONLY)

Press **SP/LP (//)**. Check the SP/LP indicator on the recorder display panel to confirm the selected tape speed.

4

## START RECORDING

Press and hold **RECORD** and **PLAY** on the remote control, or press **RECORD** on the recorder.

**With HR-J648E/J648EH/J448E:**  
B.E.S.T. takes place at the beginning of both the first SP and the first LP recording after inserting the cassette (☞ pg. 18).

**With HR-J248E:**  
B.E.S.T. takes place at the beginning of the first recording after inserting the cassette (☞ pg. 18).

5

## PAUSE/RESUME RECORDING

Press **PAUSE**. Press **PLAY** to resume recording.

6

## STOP RECORDING

Press **STOP** on the remote control or **STOP/EJECT** on the recorder. Then press **STOP/EJECT** to remove the cassette.

### Accidental erasure prevention

- To prevent accidental recording on a recorded cassette, remove its safety tab. To record on it later, cover the hole with adhesive tape.

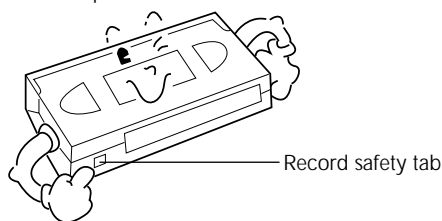

# B.E.S.T. Picture System

Turn on the TV and select the VIDEO channel (or AV mode).

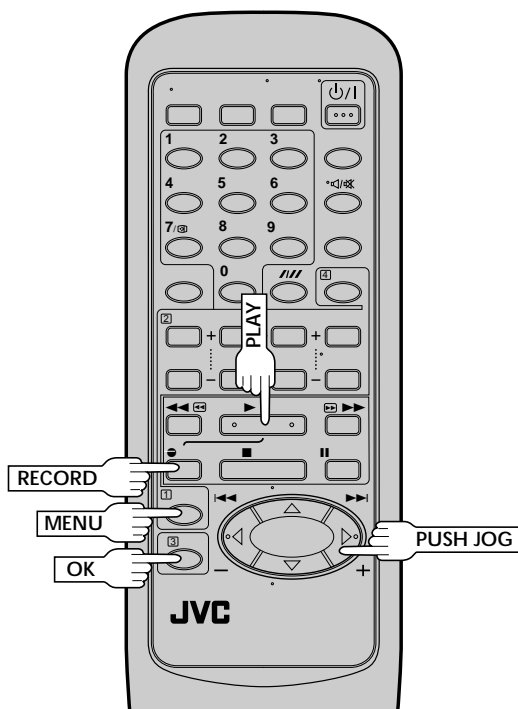
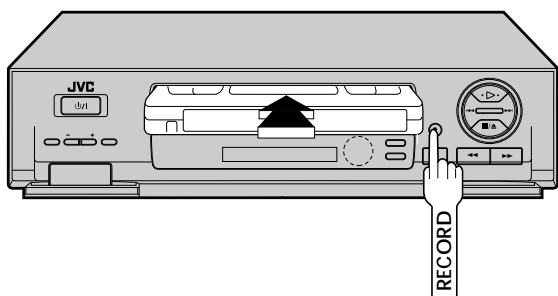

## Display Panel Indication



As the tape check progresses, the "--" marks on the display panel increase upward. Once the "BEST" indicator starts blinking, the check is complete.

The B.E.S.T. (Biconditional Equalised Signal Tracking) system checks the condition of the tape in use during recording and playback, and compensates to provide the highest-possible recording and playback pictures. The default setting for both recording and playback is "ON".

## Recording

1

### LOAD A CASSETTE

Insert a cassette with the record safety tab intact.

- The recorder power comes on automatically.

2

### ACCESS MAIN MENU SCREEN

Press **MENU** twice.

3

### ACCESS MODE SET SCREEN

Move the highlight bar (pointer) to "MODE SET" by pressing **PUSH JOG**  $\Delta$   $\nabla$ , then press **OK**.

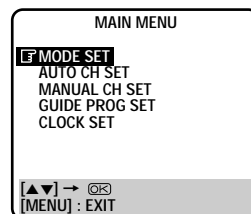

4

### CONFIRM B.E.S.T. STATUS

The default setting is "ON". If this is the case, go to step 5. If not, press **PUSH JOG**  $\nabla$  to move the highlight bar (pointer) to "B.E.S.T.", then press **PUSH JOG**  $\triangleright$  to set to "ON".

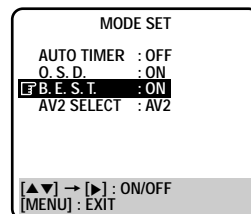

5

### RETURN TO NORMAL SCREEN

Press **MENU**.

6

### START RECORDING

Press and hold **RECORD** and **PLAY** on the remote, or press **RECORD** on the recorder.

- The recorder spends approximately 7 seconds assessing the condition of the tape, then begins recording.
- When the "BEST" indicator begins blinking, that means adjustment is complete.
- Pressing the recorder's **RECORD** button while "BEST" is displayed does not start Instant Timer Recording (see pg. 23).

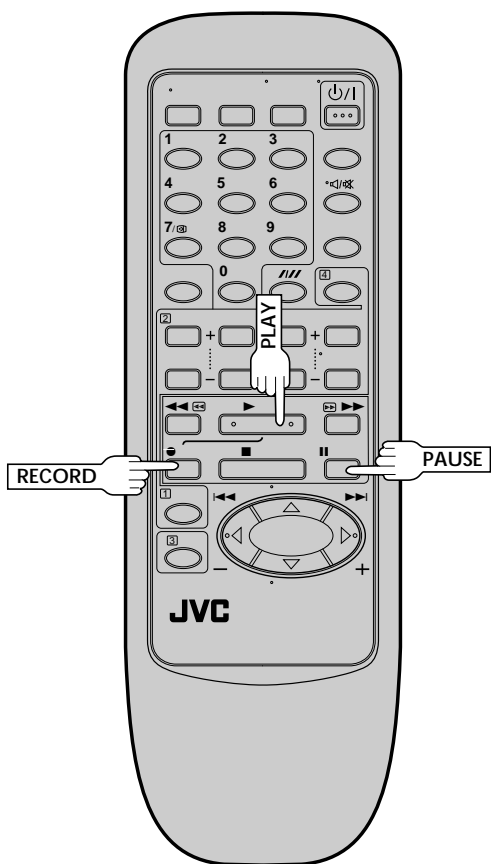
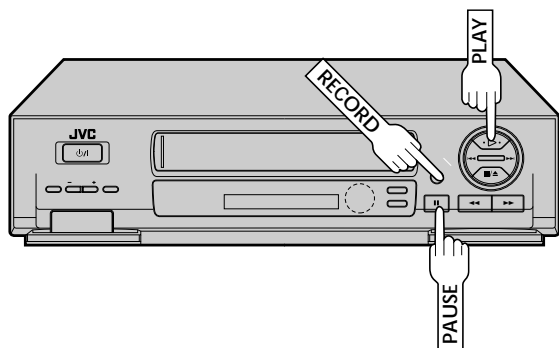

## NOTES:

- **With HR-J648E/J648EH/J448E:**

The B.E.S.T. system works for both SP and LP modes only after a tape has been inserted and the Record mode is first initiated. It does not work during recording.

- **With HR-J248E:**

The B.E.S.T. system works only after a tape has been inserted and the Record mode is first initiated. It does not work during recording.

- In the case of timer recording, the B.E.S.T. system works before recording is initiated.
- Once the cassette is ejected, the B.E.S.T. data is cancelled. The next time the cassette is used for recording, B.E.S.T. is re-performed.

## ATTENTION:

*Since the B.E.S.T. system works before recording actually starts, there is a delay of approximately 7 seconds after **RECORD** and **PLAY** on the remote are pressed, or **RECORD** on the recorder is pressed. To make sure you record the desired scene or programme in its entirety, first perform the following steps:*

- 1) Press and hold **PAUSE** and **RECORD** to engage the RECORD PAUSE mode.
  - The recorder then automatically checks the condition of the tape and, after approximately 7 seconds, re-enters RECORD PAUSE.
- 2) Press **PLAY** to start recording.
  - If you want to bypass the B.E.S.T. system and begin recording immediately, set "B.E.S.T." to "OFF" in step 4 on page 18.

## Playback

The recorder assesses the quality of the tape once you initiate playback.

When watching a tape recorded with "B.E.S.T." set to "ON", it is recommended that you leave B.E.S.T. on during playback as well.

## START PLAYBACK

# 1

Press **PLAY**.



- The recorder adjusts the playback picture quality based on the quality of the tape in use.
- B.E.S.T. is active during Auto Tracking. "BEST" appears blinking on the recorder's display panel.

## NOTES:

- When watching a rental tape or one recorded on another video recorder, or when using this recorder as the player for editing, set B.E.S.T. to your preference by performing steps 2 through 5 on page 18.
- "BEST" only appears at the beginning of automatic tracking. Even though it doesn't appear after that, the B.E.S.T. function is operative.

# On-Screen Displays

Turn on the TV and select the VIDEO channel (or AV mode).

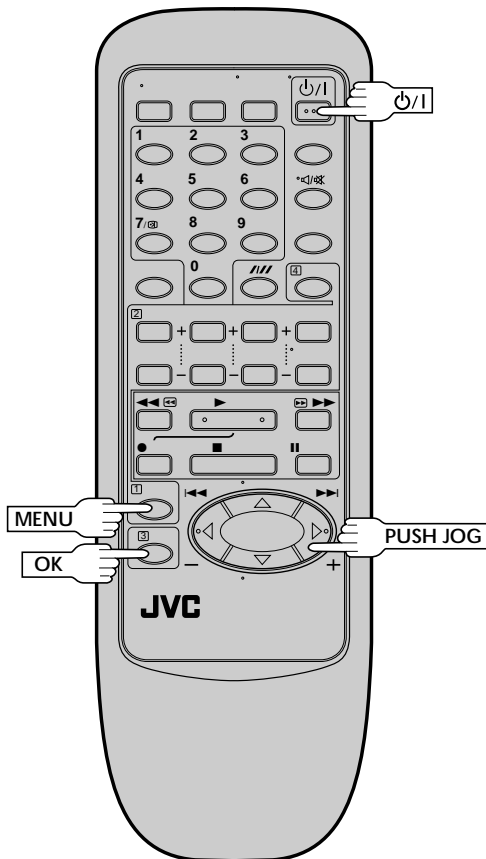

You can choose whether or not to have various operational indicators appear on screen, by setting this function ON or OFF. Messages appear in the selected language (☞ pg. 6 or 7).

## 1 TURN ON THE RECORDER

Press **⏻/I**.

## 2 ACCESS MAIN MENU SCREEN

Press **MENU** twice.

## 3 ACCESS MODE SET SCREEN

Move the highlight bar (pointer) to "MODE SET" by pressing **PUSH JOG**  $\Delta$ / $\nabla$ , then press **OK**.

## 4 ENABLE/DISABLE ON-SCREEN DISPLAY

The default setting is "ON", so if you want on-screen displays, leave the setting as it is and go to step 5. If you don't want the displays to appear, press **PUSH JOG**  $\Delta$ / $\nabla$  to move the highlight bar (pointer) to "O.S.D." and press **PUSH JOG**  $\triangleright$  to set "O.S.D." to "OFF".

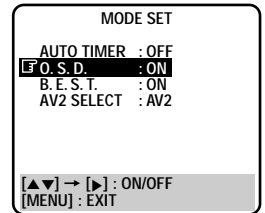

## 5 RETURN TO NORMAL

Press **MENU**.

### NOTES:

- When you use this recorder as the player for editing, be sure to set "O.S.D." to "OFF" before starting.
- During playback, the operation mode indicators may be disturbed depending on the type of tape being used.

The superimposed indication on the TV screen tells you what the recorder is doing.

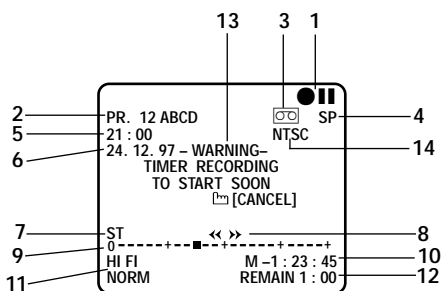

- 1- Operation mode indicators
- 2- Channel position number and station name/Aux. indicator (AUX1 or AUX2)
- 3- Cassette loaded mark
- 4- Tape speed SP/LP/EP (EP is for NTSC playback only) (HR-J648E/EH, J448E only)
- 5- Clock display
- 6- Current day/month/year
- 7- Type of Broadcast (☞ pg. 22) (HR-J648E/EH only)
- 8- Tape direction
- 9- Tape position indicator (☞ pg. 15)
- 10- Counter display (including Counter Memory indicator)
- 11- Audio mode display (☞ pg. 16) (HR-J648E/EH only)
- 12- Tape remaining time indicator (☞ pg. 21)
- 13- Timer warning display (☞ pg. 29)
- 14- NTSC/MESECAM display (☞ pg. 15)

# Recording Features

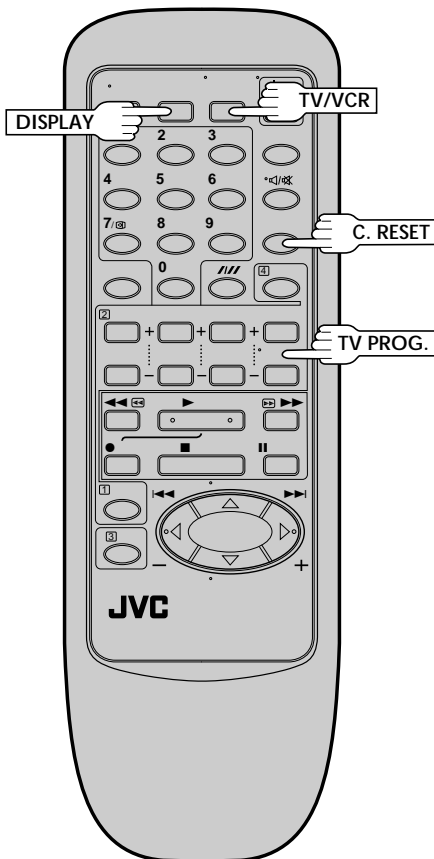
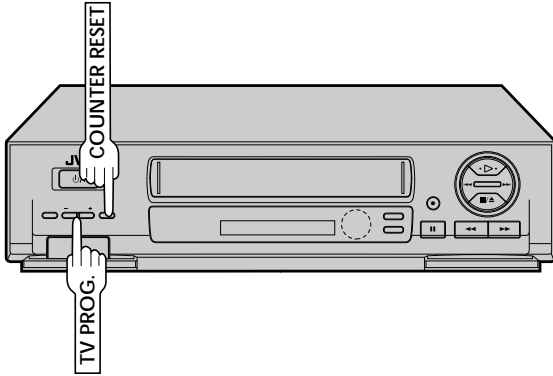

## Record One Programme While Watching Another

If your recorder is connected to the TV via AV connection, . . . . . press **TV/VCR**. The recorder's VCR indicator and the TV broadcast being recorded disappear.

### 1 SELECT CHANNEL TO WATCH

Once recording is in progress, all you need to do is to set the channel controls on the TV for the station you wish to view.

- The programme selected with the TV's channel controls appears on the TV screen while the one selected with the recorder's **TV PROG.** buttons is recorded on the tape.
- If a decoder is connected to the recorder (see pg. 33), you can select a scrambled channel as well with the TV channel controls.

## Elapsed Recording Time Indication

You can check the exact time of a recording.

### 1 SET COUNTER DISPLAY

Press **DISPLAY** until a counter reading appears on the display panel.

### 2 RESET COUNTER

Press **C.(COUNTER) RESET** before starting recording or playback.

- The counter is reset to "0:00:00" and shows the exact elapsed time as the tape runs.

## Tape Remaining Time

### 1 DISPLAY REMAINING TIME

Press **DISPLAY** until the time remaining on the tape appears.

- By pressing the **DISPLAY** button, you can change the display to show the counter reading, channel position\*, clock time or tape remaining time.  
\* channel position is not displayed during playback.

### NOTE:

Depending on the type of tape used, there may be times when the tape remaining time reading may not appear right away, or is not correct. "- : -" may sometimes appear, or the display may blink on occasion.

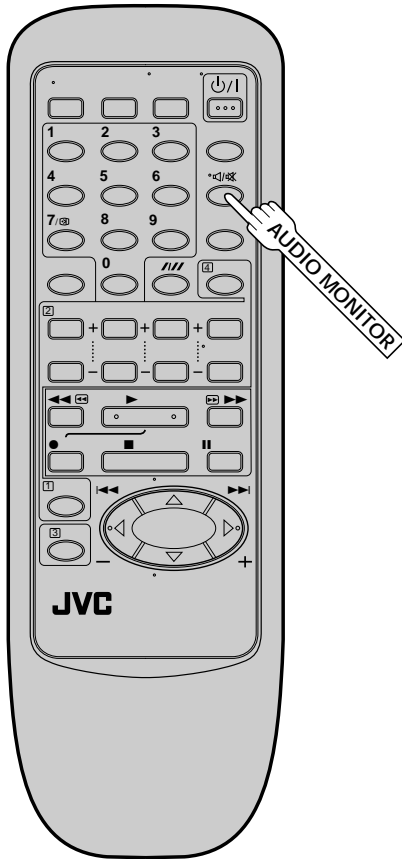

## Receiving Stereo And Bilingual Programmes (HR-J648E/EH only)

Your recorder is equipped with a Sound-Multiplex decoder (A2) and, if you own the HR-J648EH, a Digital stereo sound decoder (NICAM) as well, making reception of stereo and bilingual broadcasts possible.

When the channel is changed, the type of broadcast being received will be displayed on the TV screen for a few seconds.

Type of Broadcast Being Received	On-screen Display
A2 Stereo	ST
A2 Bilingual	BIL
Regular Monaural	(none)
*NICAM Stereo	ST NICAM
*NICAM Bilingual	BIL NICAM
*NICAM Monaural	NICAM

\*Available with HR-J648EH only.

- To listen to a stereo programme, press **AUDIO MONITOR** until "HIFI L [L] R" appears on the TV screen.
- To listen to a bilingual programme, press **AUDIO MONITOR** until either "HIFI L [L] R" or "HIFI [L] R" appears on the TV screen (as required).
- To listen to the Standard (regular monaural) audio while receiving a NICAM broadcast, press **AUDIO MONITOR** until "NORM" appears on the TV screen. (HR-J648EH only)

### NOTE:

"O.S.D." must be set to "ON" or the on-screen displays will not appear (☞ pg. 20).

## To Record Stereo And Bilingual Programmes (A2) (HR-J648E/EH only)

- Stereo programmes are automatically recorded in stereo on the Hi-Fi audio track (with the normal audio track recording mixed L and R channel sound).
- Bilingual programmes are automatically recorded in bilingual on the Hi-Fi audio track. The main soundtrack will be recorded on the normal audio track.

### NOTES:

- If the quality of stereo sound being received is poor, the broadcast will be received in monaural with better quality.
- Before playing back a programme recorded in stereo, or a bilingual programme, refer to "Soundtrack Selection" (☞ pg. 16).

## To Record NICAM Stereo And Bilingual Programmes (HR-J648EH only)

- The NICAM audio programme will be recorded on the Hi-Fi audio track, and the Standard audio programme on the normal audio track.

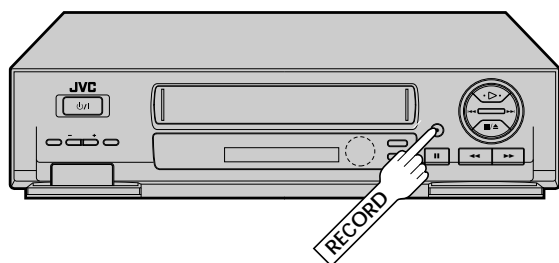

## Instant Timer Recording (ITR)

This easy method lets you record for from 30 minutes to 6 hours (selectable in 30-min. increments), and shuts the recorder off after recording is finished.

### 1 START RECORDING

Press **RECORD** on the recorder.

### 2 ENGAGE ITR MODE

Press **RECORD** again. "O" blinks and 0:30 appears on the front display panel.

### 3 SET RECORDING DURATION

If you want to record for more than 30 minutes, press **RECORD** to extend the time. Each press extends recording time by 30 minutes.

#### **NOTE:**

*You can only perform ITR using the **RECORD** button on the recorder's front panel.*

# SHOWVIEW Timer Recording

Before performing SHOWVIEW timer recording:

- Be sure to read "SHOWVIEW Setup" (pg. 10).
- Insert a cassette with the safety tab in place. The recorder will come on automatically.
- Turn on the TV and select the VIDEO channel (or AV mode).

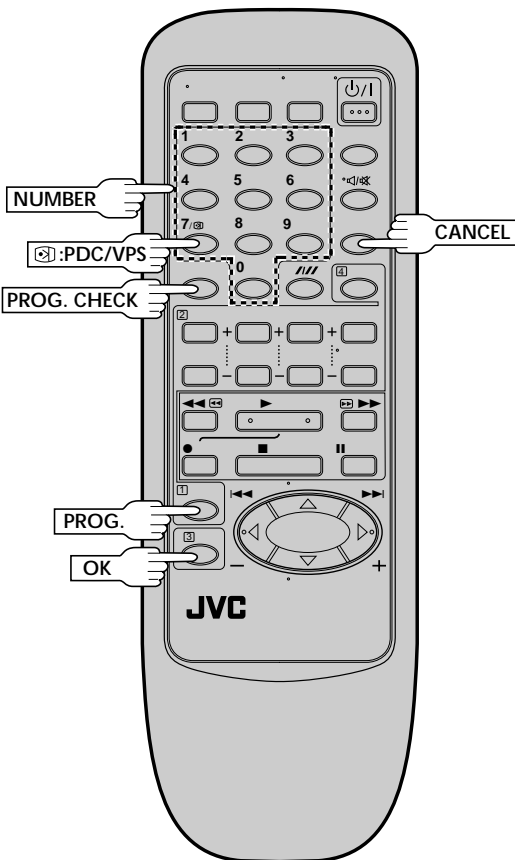
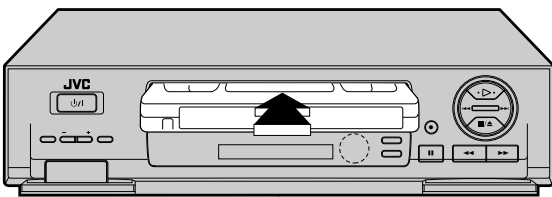

1

## ACCESS TIMER PROGRAMMING SCREEN

Press **PROG.**

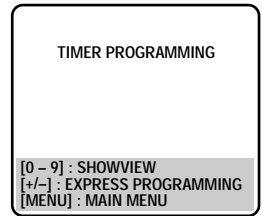

The front display panel looks like this:



2

## ENTER SHOWVIEW NUMBER

Press the **NUMBER** keys to enter the SHOWVIEW number of a programme you wish to record.

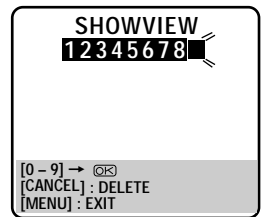

- If you make a mistake, press **CANCEL** to backspace and then input the correct number.

The SHOWVIEW number you enter appears on the front display panel:



The display panel can only show 4 digits at a time.

3

## ACCESS SHOWVIEW PROGRAM SCREEN

Press **OK**, and the SHOWVIEW Program screen appears (if you're just starting out, "P1" appears).

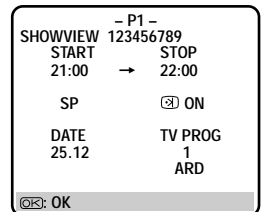

The display panel shows the programme start time. Pressing **PROG. CHECK** changes the display to the programme stop time, then the date and channel position.



### IMPORTANT

Be sure to confirm the setting of PDC/VPS recording.

- If "ON" is displayed on the screen or "ON" is lit on the display panel, PDC/VPS is set to ON.
- If "OFF" is displayed on the screen or "OFF" is not lit on the display panel, PDC/VPS is set to OFF.

To change the setting, press **PDC/VPS** (NUMBER key "7").  
 See "PDC/VPS Recording" on page 29.

- Make sure the channel position number you wish to record is displayed; if not, see "SHOWVIEW Setup" on page 10 and set the Guide Program number for that SHOWVIEW number correctly.
- If the number you entered is invalid, "ERROR" appears on the screen and "Err" appears on the display panel. Press **CANCEL** to backspace and input a valid SHOWVIEW number.
- If "ERROR=GUIDE PROG" appears on the screen, see "ATTENTION - Regarding Guide Program Number Set" on page 25.



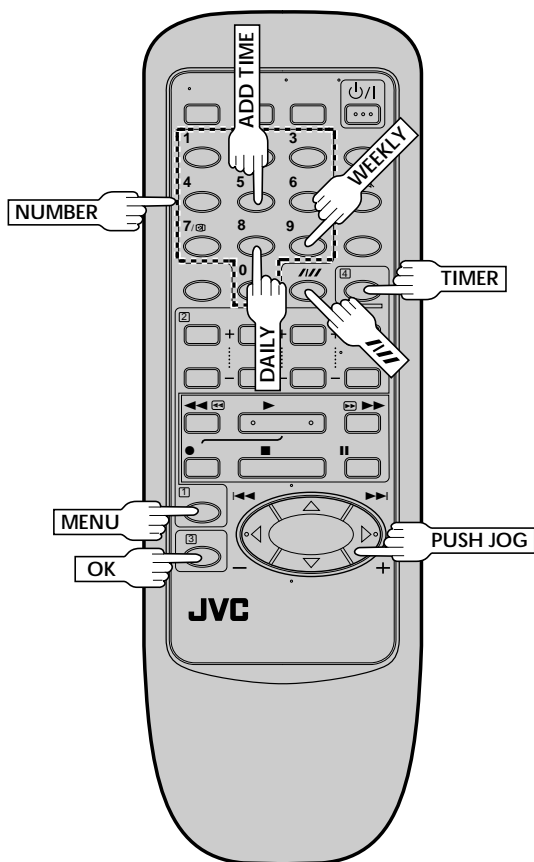
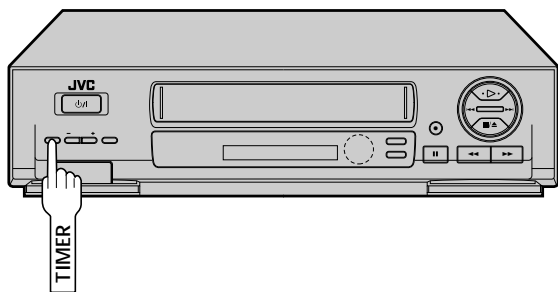

### Satellite Tuner Users

To timer-record a satellite broadcast using ShowView, perform steps 1 – 6 and, before the selected programme begins, select the appropriate channel on the satellite tuner. Then set the tuner's timer. If your satellite tuner doesn't have a timer, leave the unit's power switched on.

## 4 SET TAPE SPEED (HR-J648E/ J648EH/J448E ONLY)

Press **SP/LP** ( ) to set the tape speed.

## 5 RETURN TO NORMAL SCREEN

Press **OK**.

- Repeat steps 1–5 for each additional programme.

## 6 ENGAGE RECORDER'S TIMER MODE

Press **TIMER**. The recorder turns off automatically.

### NOTE:

*To Delay The Stop Time . . .*

. . . press **ADD TIME** (NUMBER Key "5") after pressing **OK** in step 3. Each time you press, the Stop time is delayed by 5 minutes (meaning that 5 minutes of recording time is added). You can easily compensate for anticipated programme schedule delays this way.

*To Timer-Record Weekly Or Daily Serials . . .*

. . . after pressing **OK** in step 3, press **WEEKLY** (NUMBER key "9") for weekly serials or **DAILY** (NUMBER key "8") for daily serials (Monday–Friday). Either "WEEKLY" or "DAILY" appears on the screen. Pressing the button again makes the corresponding indication disappear.

You can programme this recorder to timer-record as many as 8 programmes. If you try to programme the recorder to record a ninth, "PROGRAM FULL" appears on screen and "FULL" appears on the front display panel. To record the extra programme, you must first cancel any unnecessary programmes ( pg. 28).

### ATTENTION

#### Regarding Guide Program Number Set

"ERROR=GUIDE PROG" appears after performing step 3 on the previous page if the Guide Program number for the ShowView number you entered has not been set.

- If the recorder is in the stop or rewind or fast-forward mode, the following screen will appear with "--" under "TV PROG" blinking.
- Press the **NUMBER** keys or **PUSH JOG**  $\Delta \nabla$  to input the channel position number you recorder receives that station on, then press **OK**.

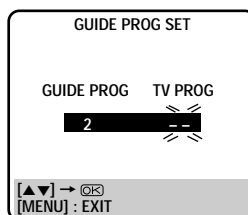

(Ex.) To timer-record a ZDF programme with ShowView  
\* If your recorder receives ZDF on the channel position 2, press **OK** after entering "2".

- Press **MENU**, then try again from step 1.
- If the recorder is in a mode other than the above mentioned modes, press **MENU** first and input the correct Guide Program number for that ShowView number ( pg. 10, "SHOWVIEW Setup"), then try again from step 1.

# Regular Timer Programming

Remember, the clock must be set before you can programme the timer (see pg. 39).

Before performing the following steps:

- Insert a cassette with the safety tab in place. The recorder will come on automatically.
- Turn on the TV and select the VIDEO channel (or AV mode).

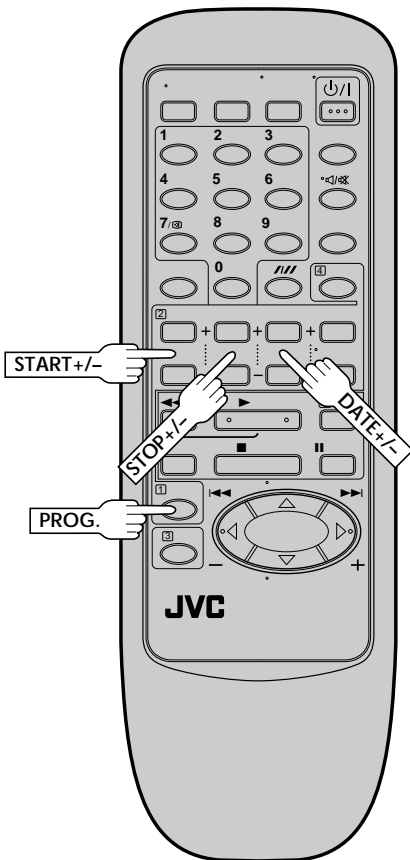
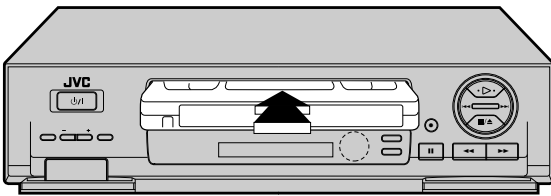

If you don't know the SHOWVIEW number for the programme you wish to record, use the following procedure to set your recorder to timer-record the programme.

## 1 ACCESS TIMER PROGRAMMING SCREEN

Press **PROG.**

## 2 ACCESS PROGRAMME SCREEN

Press **START +/-**. (If you're just starting out, "P1" appears.)

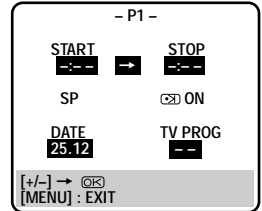

The front display panel looks like this:



## 3 ENTER PROGRAMME START TIME

Press **START +/-** to enter the time you want recording to start.

- Press and hold **START +/-** to move in 30-minute increments, or press and release repeatedly to move 1 minute at a time.

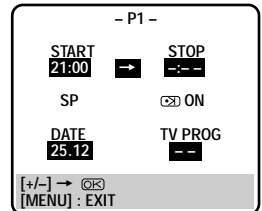

The front display panel looks like this:



## 4 ENTER PROGRAMME STOP TIME

Press **STOP +/-** to enter the time you want recording to stop.

## 5 ENTER PROGRAMME DATE

Press **DATE +/-**. (The current date appears on screen. The date you enter appears in its place.)

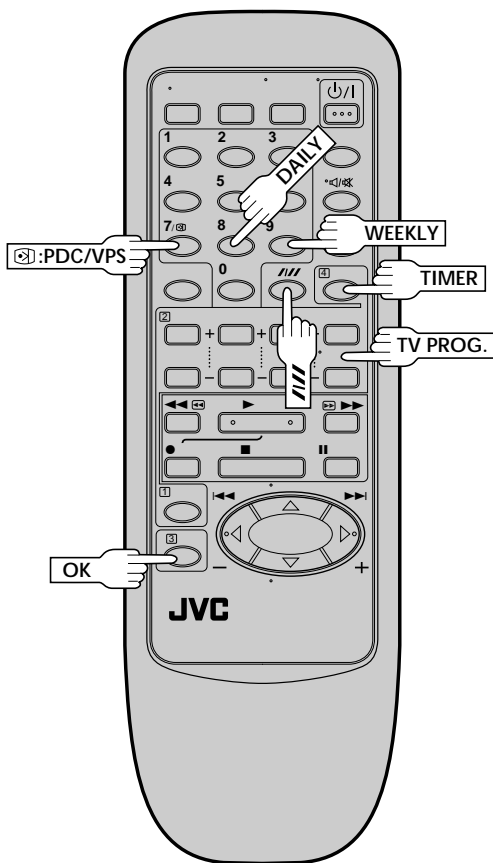
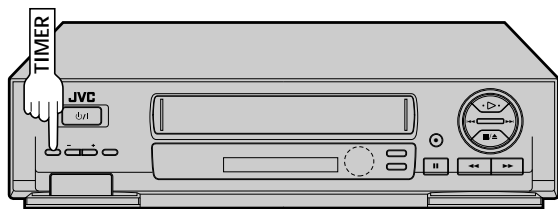

## 6 ENTER CHANNEL POSITION

Press **TV PROG. +/-**.

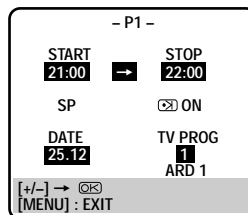

### IMPORTANT

Be sure to confirm the setting of PDC/VPS recording.  
 ● If "ON" is displayed on the screen or "ON" is lit on the display panel, PDC/VPS is set to ON.  
 ● If "OFF" is displayed on the screen or "OFF" is not lit on the display panel, PDC/VPS is set to OFF.  
 To change the setting, press **PDC/VPS** (NUMBER key "7").  
 ☞ "PDC/VPS Recording" on page 29.

## 7 SET TAPE SPEED (HR-J648E/ J648EH/J448E ONLY)

Press **SP/LP ( // )** to set the tape speed.

## 8 RETURN TO NORMAL SCREEN

After confirming all information is correct, press **OK** and the normal screen appears.

- Repeat steps 1-8 for each additional programme.

## 9 ENGAGE RECORDER'S TIMER MODE

Press **TIMER**. The recorder turns off automatically.

*To Timer-Record Weekly Or Daily Serials . . .*  
 . . . anytime during steps 2 through 8, press **WEEKLY** (NUMBER key "9") for weekly serials or **DAILY** (NUMBER key "8") for daily serials (Monday-Friday). Either "WEEKLY" or "DAILY" appears on the screen. Pressing the button again makes the corresponding indication disappear.

### NOTES:

- To timer-record a satellite broadcast through a satellite tuner connected to the AV2 IN/DECODER connector on the back of the recorder, in step 6 above, set "TV PROG" to "AUX2" by pressing **TV PROG. +/-**. Before the selected programme begins, select the appropriate channel on the satellite tuner, then set the tuner's timer. If your satellite tuner doesn't have a timer, leave the unit's power switched on.
- You can programme this recorder to timer-record as many as 8 programmes. If you try to programme the recorder to record a ninth, "PROGRAM FULL" appears on screen and "FULL" appears on the front display panel. To record the extra programme, you must first cancel any unnecessary programmes (☞ pg. 28).

## Auto Timer

When the Auto Timer is set to ON the timer is automatically engaged when the recorder power is turned off and automatically disengaged when the recorder is powered back on.

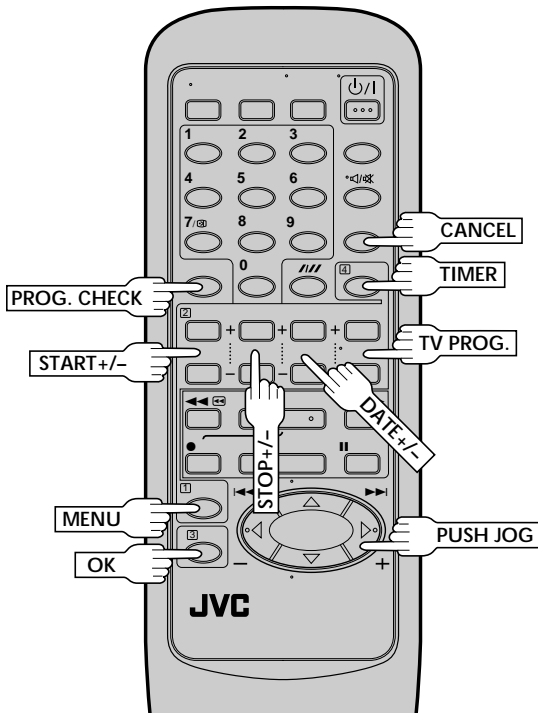

## Check And Cancel Programmes

### 1 ACCESS PROGRAMME DISPLAY AND/OR SCREEN

Press **PROG. CHECK**.

- The display panel shows the programme start time. Pressing **OK** changes the display to the programme stop time, then the date and channel position.
- If the recorder is turned on and the TV is set to its VIDEO channel or AV mode, you can check program information on screen as well.
- Each time you press **PROG. CHECK**, the next programme's information appears.

*If All Information Is Correct . . .*

. . . programming is completed.

*If You Wish To Revise Data . . .*

. . . with the recorder's power turned on, go to step 2.

*If You Wish To Cancel A Program . . .*

. . . with the recorder's power turned on, press **CANCEL**. All information you input is deleted.

### 2 REVISE PROGRAMME INFORMATION

Input the appropriate data using the **START +/-**, **STOP +/-**, **DATE +/-** and **TV PROG. +/-** buttons on the remote control.

### 1 ACCESS MAIN MENU SCREEN

Press **MENU** twice.

### 2 ACCESS MODE SET SCREEN

Press **PUSH JOG**  $\Delta$ / $\nabla$  to move the highlight bar (pointer) to "MODE SET", then press **OK**.

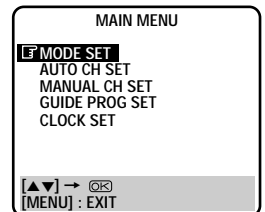

### 3 SELECT MODE

Press **PUSH JOG**  $\triangleright$  to select either "ON" or "OFF".

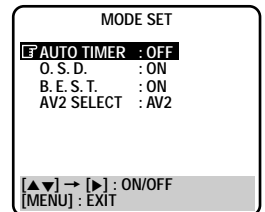

### 4 RETURN TO NORMAL SCREEN

Press **MENU**.

## NOTE:

*For safety, when Auto timer is set to "OFF", all other recorder functions are disabled while the Timer mode is engaged. To disengage the timer, press **TIMER**.*

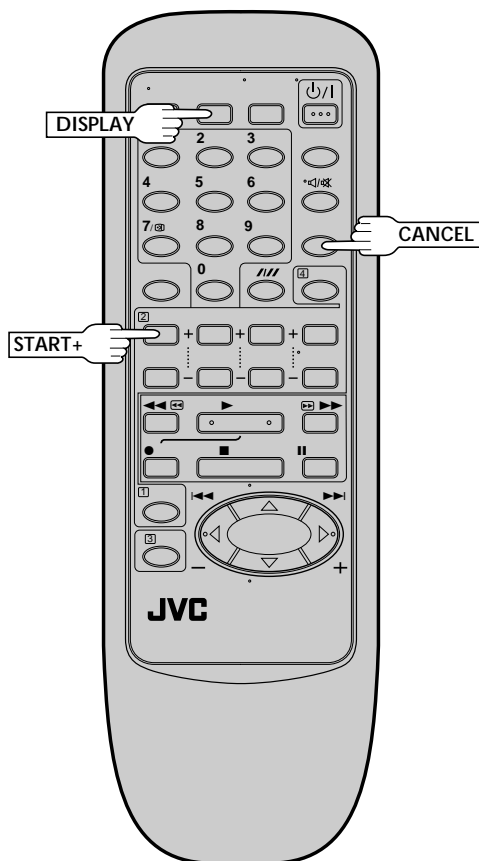

## Timer Warning

If you have programmed your recorder to timer-record a programme or a series of programmes, a warning appears on screen to tell you that the recording is to start in 5 minutes.

- WARNING -  
TIMER RECORDING  
TO START SOON  
[CANCEL]

### NOTES:

- The warning only appears if you're not in the Timer mode at that time.
- If this recorder is being used as the player for tape dubbing, the warning screen is recorded on the tape in the other video recorder.

The warning blinks for the entire 5 minutes leading up to the start of timer recording. To clear the display, press **CANCEL**.

## PDC/VPS Recording

Now available from some TV stations, PDC (Programme Delivery Control) and VPS (Video Programme System) are services designed to assure safe, accurate timer recording. With this system, special code signals are transmitted together with the audio/video signals. These code signals control your video recorder and have precedence over advertised times you preset in the timer. This means that your recorder will start and stop recording when the preset TV programmes actually start and end — even if the broadcast time of a preset TV programme is changed.

### NOTES:

- When you manually enter programmes (regular timer programming), set the start time (PDC or VPS time) exactly as advertised in the TV listing. A different time than advertised will result in no recording.
- PDC/VPS recording is also possible when a satellite tuner or a cable system is connected to the AV2 IN/DECODER connector on your recorder.
- PDC/VPS recording is also possible via the AV1 IN/OUT connector and the front panel connectors.

### How to check if the station being received transmits a PDC/VPS signal

- 1 Press **DISPLAY** until the channel position appears on the display panel.
- 2 Hold down **START +** for about 5 seconds.
  - "Ⓚ" appears blinking on the display panel.
  - If a PDC/VPS signal is detected from the station, "Ⓚ" will stop blinking.*
  - If no PDC/VPS signal is detected from the station, "Ⓚ" will blink at a slower rate.*
- 3 Press **DISPLAY** or **START +** again to return to normal display.

# Edit To Or From Another Video Recorder

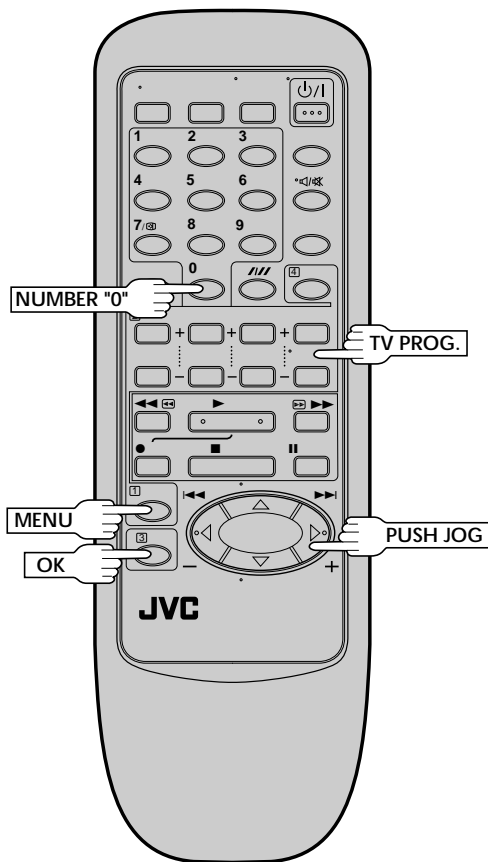

You can use your video recorder as the source player or the recording deck.

## 1 MAKE CONNECTIONS

Connect the player's 21-pin SCART connector to the recorder's 21-pin SCART connector as illustrated on page 33.

*When Using Your Video Recorder As The Source Player . . .*

. . . connect its AV1 IN/OUT connector to the recording deck.

*When Using Your Video Recorder As The Recording Deck . . .*

. . . connect its AV2 IN/DECODER or AV1 IN/OUT connector to the source player.

## 2 SET RECORDING DECK'S INPUT MODE

Set to AUX. With this video recorder, press **NUMBER** key "0" and/or **TV PROG.** to select depending on the connector being used — "AU-1" for the AV1 IN/OUT connector, or "AU-2" for the AV2 IN/DECODER connector.

- When using the AV2 IN/DECODER connector, make sure "AV2 SELECT" is set to "AV2" (see below).

## 3 START SOURCE PLAYER

Engage its Play mode.

## 4 START RECORDING DECK

Engage its Record mode.

### NOTE:

*All necessary cables can be obtained from your dealer.*

## AV2 SELECT Setting

- 1 Press **MENU** twice to access the Main Menu screen.
- 2 Press **PUSH JOG**  $\Delta \nabla$  to move the highlight bar (pointer) to "MODE SET", then press **OK**.
- 3 Press **PUSH JOG**  $\Delta \nabla$  to move the highlight bar (pointer) to "AV2 SELECT".
- 4 Press **PUSH JOG**  $\triangleright$  to move the highlight bar (pointer) to your choice:
  - a-AV2 : To use this recorder as the recording deck with the player connected to the AV2 IN/DECODER connector.
  - b-DECODER : To use a decoder connected to the AV2 IN/DECODER connector.
- 5 Press **MENU** to return to normal screen.

- If you have a decoder, be sure to set "AV2 SELECT" back to "DECODER" after editing.
- If you're not using a decoder, leave "AV2 SELECT" set to "AV2".
- The default setting is "AV2"; if the recorder's memory backup has expired due to a power cut or because the AC was removed from the recorder, "AV2" will be automatically selected when the power is restored to the recorder. If you are using a decoder, be sure to set "AV2 SELECT" back to "DECODER".

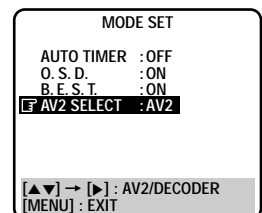

## HR-J648E/EH

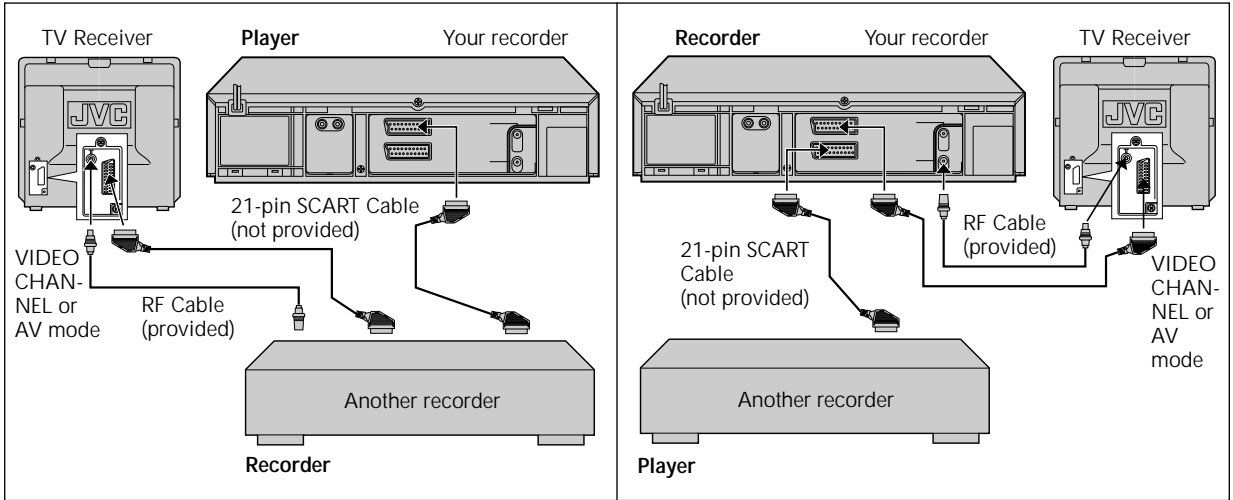

## HR-J448E/J248E

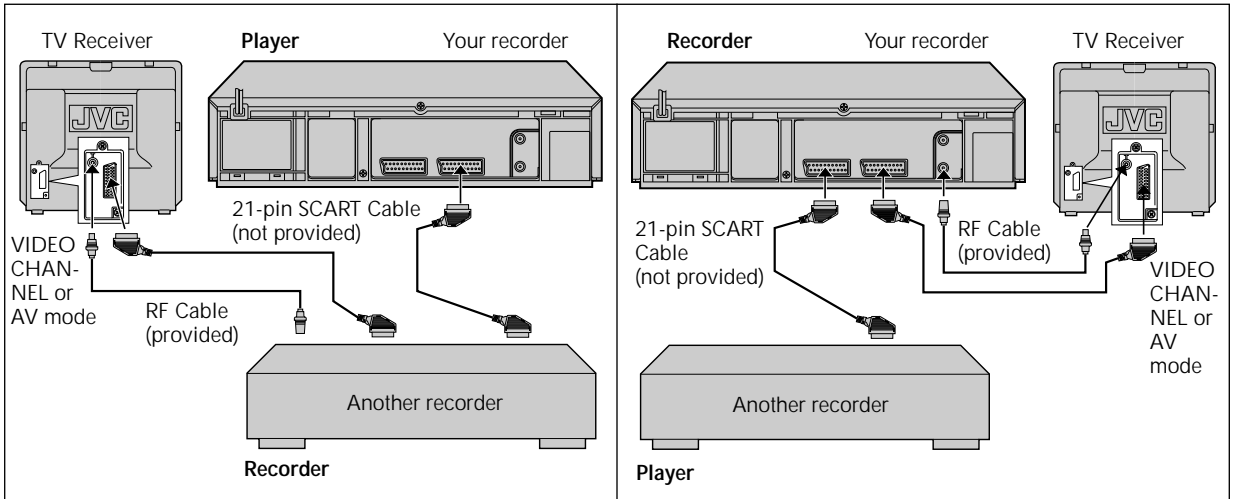

# Edit From A Camcorder

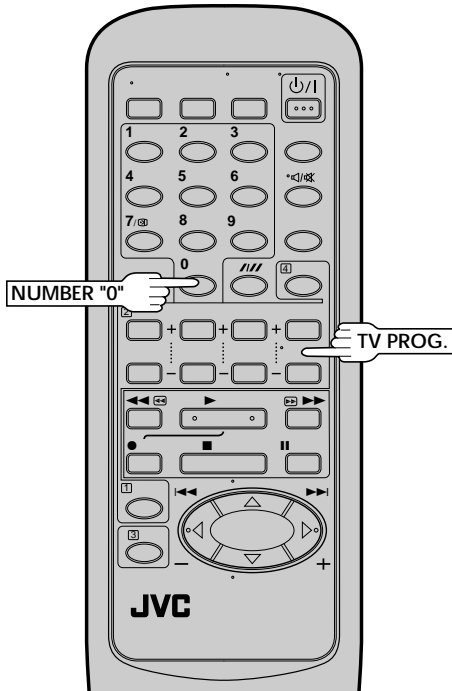

You can use a camcorder as the source player and your video recorder as the recorder.

- 1** MAKE CONNECTIONS  
Connect the camcorder's AUDIO/VIDEO OUT connectors to the recorder's AUDIO/VIDEO input connectors.
- 2** SET RECORDER'S INPUT MODE  
Press **NUMBER** key "0" and/or **TV PROG.** to select depending on the connector being used — "AU-1" for the AV1 IN/OUT connector, or "AU-2" for the AV2 IN/DECODER connector.
  - When using the AV2 IN/DECODER connector, make sure "AV2 SELECT" is set to "AV2" (ⓘ pg. 30).
- 3** START CAMCORDER  
Engage its Play mode.
- 4** START RECORDER  
Engage its Record mode.

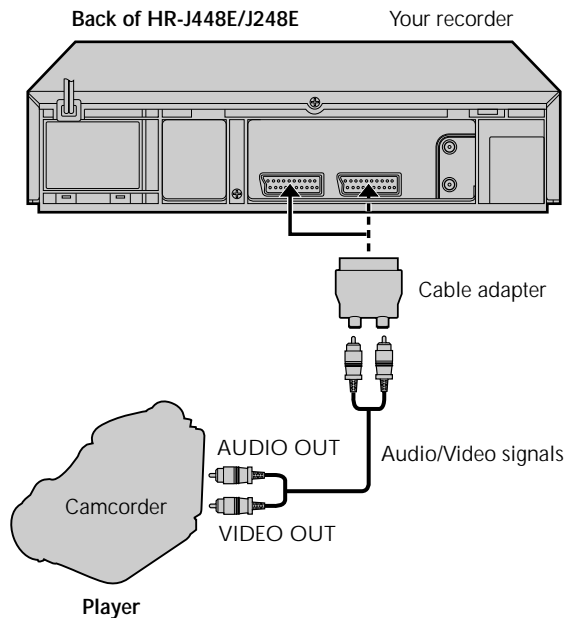
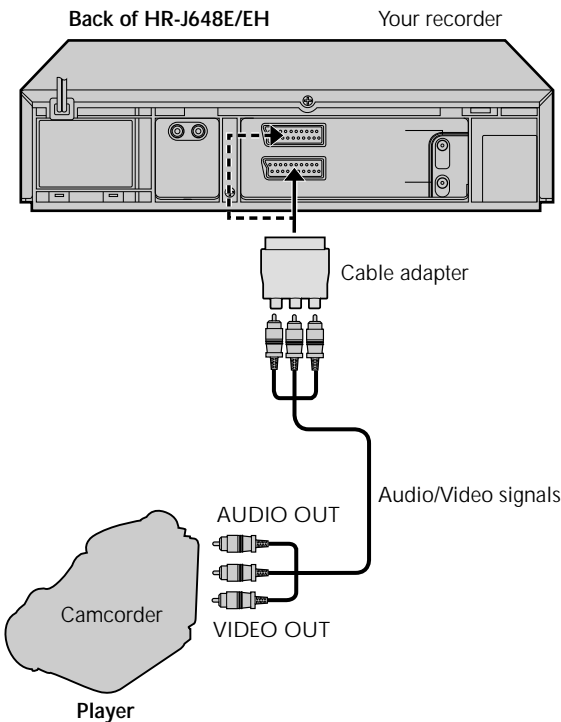



# Connecting/ Using A Decoder

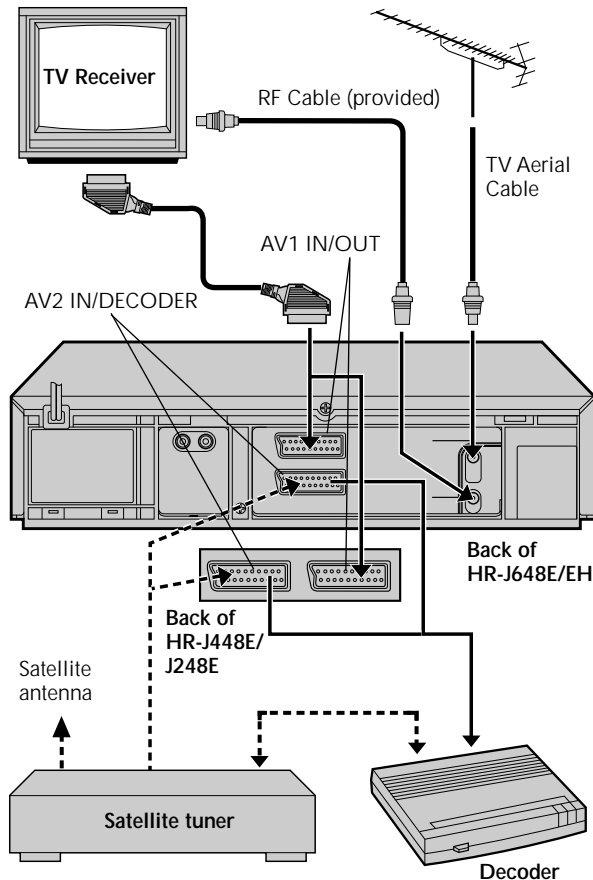

The AV2 IN/DECODER connector can be used as an input terminal for an external decoder (descrambler). Simply connect a decoder and you can enjoy the variety of programming that is available through scrambled channels.

## 1 SELECT INPUT MODE

Set "AV2 SELECT" to "DECODER". (☞ pg. 30)

## 2 CONNECT DECODER

Connect your recorder's AV2 IN/DECODER connector to the decoder's Euroconnector using a 21-pin SCART cable.

## 3 SET TUNER

Perform the procedure as described in "When Receiving A Scrambled Broadcast" on page 36.

### NOTE:

#### When Connecting A Satellite Tuner . . .

. . . if you don't have a decoder connect the satellite tuner directly to the video recorder's AV2 IN/DECODER connector.  
 . . . if you have a decoder, first connect the decoder to the decoder input of the satellite tuner, then connect the satellite tuner's output to the recorder's AV2 IN/DECODER connector. Refer to the instruction book for the satellite tuner and decoder.  
 . . . set "AV2 SELECT" to "AV2". (☞ pg. 30)  
 . . . to view a programme via the satellite tuner, select AU 2 mode by pressing **NUMBER** keys and/or **TV PROG.** so that "AU-2" appears on the display panel.

Turn on the TV and select the VIDEO channel (or AV mode).

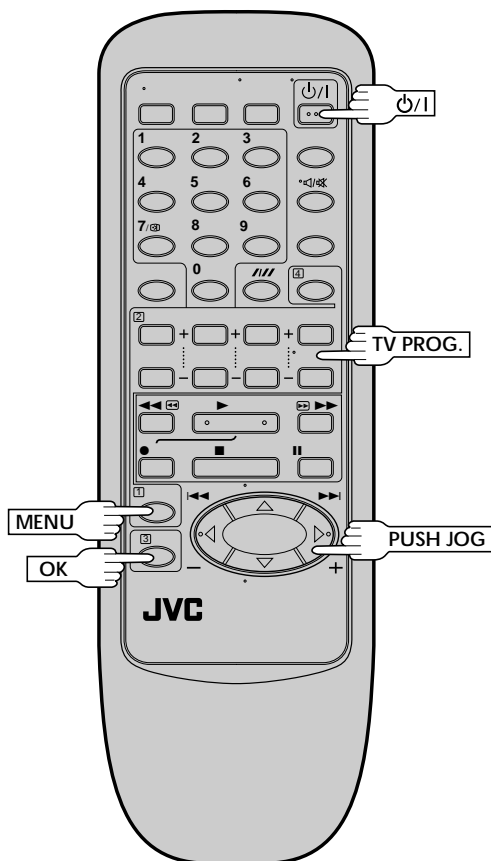

### IMPORTANT

Perform the following steps only if auto channel set has not been set correctly by Auto Set Up function (pg. 4) or if you have moved to a different area or if a new station starts broadcasting in your area.

Your recorder needs to memorise all necessary stations in channel positions in order to record TV programmes. Auto Channel Set automatically assigns all receivable stations in your area so that you can call them up with the **TV PROG.** buttons without going through any vacant channels.

## Auto Channel Set

### 1 TURN ON THE RECORDER

Press **⏻/I**.

### 2 ACCESS MAIN MENU SCREEN

Press **MENU** twice.

### 3 ACCESS COUNTRY SET SCREEN

Press **PUSH JOG**  $\Delta$   $\nabla$  to move the highlight bar (pointer) to "AUTO CH SET", then press **OK**.

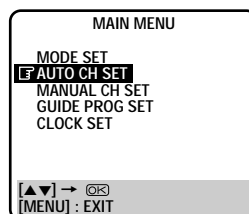

### 4 SELECT COUNTRY

Press **PUSH JOG**  $\Delta$   $\nabla$  to move the highlight bar (pointer) to your country's name, then press **OK**. The Language Set screen appears.



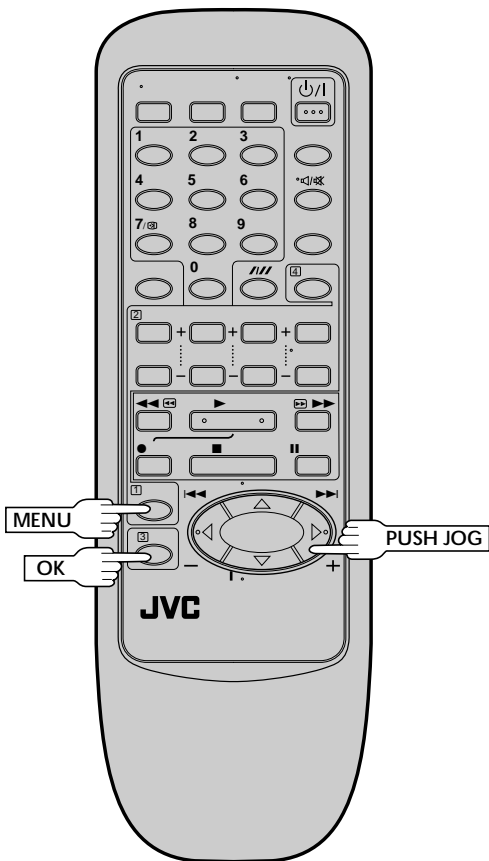

5

## PERFORM AUTO CHANNEL SET

Press **PUSH JOG**  $\Delta \nabla$  to move the highlight bar (pointer) to the language of your choice, then press **OK** to initiate Auto Channel Set.



- The Auto Set screen appears, and remains on screen while the recorder searches for receivable stations. As Auto Channel Set progresses, the "■" mark on the screen moves from left to right. Wait until the screen as shown in step 6 appears.

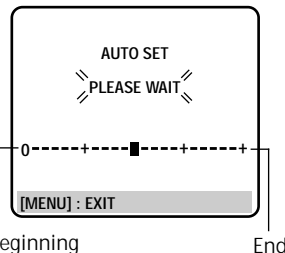

## VIEW CONFIRMATION SCREEN

6

The stations your recorder located appear on a Confirmation screen — channel positions (PR), channels (CH) and station names (ID— pg. 38). To view the next page of the listing, press **PUSH JOG**  $\Delta \nabla \triangleleft \triangleright$ . The blueback screen and the program currently being broadcast by the blinking station appear alternately for 5 seconds each.

PR	CH	ID	PR	CH	ID
01	25	ARD	08	C26	E-SP
02	C08	SKYF	09	55	WEST
03	10	ZDF	10	C24	SAT1
04	C65	RAI1	11	C23	OSF
05	C31	BBC1	12	C25	ESPN
06	C32	BBC2	13	C37	CNN
07	C33	3SAT	14		C35

- The stations located in the selected country appear at the top of the list.
- The Guide Program numbers will also be set automatically during Auto Channel Set.

## RETURN TO NORMAL SCREEN

7

Press **MENU**.

- Depending on the reception conditions, the stations may not be stored in order, and the station names may not be stored correctly.
- Using the Confirmation screen, you can skip or add channel positions, enter station names and perform other operations. Refer to pages 36 – 37 for the procedures.
- For information on scrambled broadcasts, refer to page 36.

### IMPORTANT

- Depending on the reception conditions, the station names may not be stored correctly, and auto Guide Program Number Set may not work properly. If the Guide Program numbers are not set properly, **SHOWVIEW** timer recording (pg. 24) will not work correctly; be sure to check if the Guide Program numbers have been set correctly (pg. 10, "SHOWVIEW Setup").
- Since your video recorder memorizes all detected stations even if the reception condition is poor, some of those stored stations may produce a noisy picture. To delete those stations, use "Delete A Channel" on page 36.

### NOTE:

Fine tuning is performed automatically during Auto Channel Set. If you want to perform it manually, refer to page 37.

## Storing Channels Manually

Store channels that were not stored during Auto Set Up (☞ pg. 4) or Auto Channel Set (☞ pg. 34).

- 1** **ACCESS MAIN MENU**  
Press **MENU** twice.
- 2** **ACCESS CONFIRMATION SCREEN**  
Press **PUSH JOG**  $\Delta \nabla$  to move the highlight bar (pointer) to "MANUAL CH SET", then press **OK**. The Confirmation screen appears.
- 3** **SELECT POSITION**  
Press **PUSH JOG**  $\Delta \nabla \triangleleft \triangleright$  until an open position in which you want to store a channel begins blinking, then press **OK**. The Manual Ch. Set screen appears.
- 4** **INPUT CHANNEL**  
The number "01" appears blinking beneath "CH". Press the **NUMBER** keys to input the channel number you want to store.
  - For fine tuning adjustment, press **PUSH JOG**  $\triangleright$  until the item beneath "CH" begins blinking, then press **PUSH JOG**  $\Delta \nabla$ . While tuning, "F+" or "F-" appears.
  - If necessary, to change the band between CH(regular) and CC(cable), press **PUSH JOG**  $\triangleleft \triangleright$  until CH or CC is blinking, then press **PUSH JOG**  $\Delta \nabla$  to select the band.
  - When storing a channel that sends scrambled broadcasts, press **PUSH JOG**  $\triangleright$  until "OFF" (Decoder setting) blinks, then press **PUSH JOG**  $\Delta \nabla$  to set "DECODER" to "ON" ("OFF" is the default setting).
- 5** **ENTER NEW CHANNEL INFORMATION**  
Press **OK** and the Confirmation screen appears.
  - Repeat steps **3** through **5** as necessary.
- 6** **CLOSE CONFIRMATION SCREEN**  
Press **MENU**.
  - To input the station name, see page 37.
  - To change positions, see "Change Station Channel Position" (at right).

**When Receiving A Scrambled Broadcast**  
Make sure that "AV2 SELECT" is set to "DECODER" (☞ pg. 30).

- 1- Perform steps **1** and **2** above.
- 2- Press **PUSH JOG**  $\Delta \nabla \triangleleft \triangleright$  to select the position of the channel broadcasting the scrambled programmes, then press **OK** three times.
- 3- Press **PUSH JOG**  $\triangleright$  until "OFF (Decoder setting)" begins blinking, and set it to "ON" by pressing **PUSH JOG**  $\Delta \nabla$ .
- 4- Press **OK** to access the Confirmation screen.
  - Repeat steps **2** - **4** for each additional channel.
- 5- Press **MENU**.

Perform steps **1** and **2** of the previous procedure to access the Confirmation screen before continuing.

## Delete A Channel

- 1** **SELECT ITEM**  
Press **PUSH JOG**  $\Delta \nabla \triangleleft \triangleright$  until the item you want to delete begins blinking.
- 2** **DELETE CHANNEL**  
Press **CANCEL**.
  - The item directly beneath the cancelled one moves up one line.
  - Repeat steps **1** and **2** as necessary.
- 3** **CLOSE CONFIRMATION SCREEN**  
Press **MENU**.

## Change Station Channel Position

- 1** **SELECT ITEM**  
Press **PUSH JOG**  $\Delta \nabla \triangleleft \triangleright$  until the item you want to move begins blinking. Then press **OK** and the station name (ID) and its channel (CH) number begin blinking.
- 2** **SELECT NEW POSITION**  
Press **PUSH JOG**  $\Delta \nabla \triangleleft \triangleright$  to move the station to the new channel position, then press **OK**.  
**Example:** If you moved the station in position 3 to position 7, the stations originally in positions 4-7 each move up one space.
  - Repeat steps **1** and **2** as necessary.
- 3** **CLOSE CONFIRMATION SCREEN**  
Press **MENU**.

Perform steps 1 and 2 of "Storing Channels Manually" on page 36 to access the Confirmation screen before continuing.

## Fine-Tuning Channels Already Stored

### Set Stations (A)

**1** **SELECT ITEM**  
Press **PUSH JOG**△▽◁▷ until the item you want begins blinking. Then press **OK** twice and the station's name (ID) begins blinking.

**2** **SELECT NEW STATION**  
Press **PUSH JOG**△▽ until the new station's name (ID) you want to store begins blinking. Registered station names (see pg. 38) appear as you press **PUSH JOG**△▽.

**3** **SWITCH STATIONS**  
Press **OK**.

- Repeat steps 1 through 3 as necessary.

**4** **CLOSE CONFIRMATION SCREEN**  
Press **MENU**.

### Set Stations (B)

#### NOTE:

First perform step 1 of the above procedure.

**2** **SELECT STATION NAME CHARACTER**

Press **PUSH JOG**▷ and the first letter of the station name begins blinking.

**3** **ENTER NEW CHARACTER**

Press **PUSH JOG**△▽ to cycle through the characters (A-Z, 0-9, -, \*, +, — (space)) and stop when the desired one is indicated, then press **PUSH JOG**▷ to enter. Enter the remaining characters the same way (maximum of 4).  
After entering all characters, press **OK**.

- Repeat steps 1 through 3 as necessary.
- If you make a mistake, press **PUSH JOG**◁ until the incorrect character begins blinking. Then enter the correct character by pressing **PUSH JOG**△▽.

**4** **CLOSE CONFIRMATION SCREEN**

Press **MENU**.

**1** **SELECT CHANNEL TO FINE-TUNE**

Press **PUSH JOG**△▽◁▷ until the channel you want to tune begins blinking.

**2** **ACCESS MANUAL CH. SET SCREEN**

Press **OK** three times. The Manual Ch. Set screen appears.

**3** **PERFORM TUNING**

Press **PUSH JOG**△▽ until the picture is its clearest. Then press **OK**.

- The Confirmation screen appears.
- Repeat steps 1 through 3 as necessary.

**4** **CLOSE CONFIRMATION SCREEN**

Press **MENU**.

## TV Station And ID List

ID*	STATION NAME
1000	TV1000
3SAT	3SAT
ADLT	ADULT
ANT3	ANTENA3
ARD	ARD
ARTE	ARTE
BBC	BBC GROUP
BBC1	BBC1
BBC2	BBC2
BR3	BAYERN3
C+	CANAL PLUS
C1	PORTUGUSES
CAN5	CANALE5
CH4	CHANNEL4
CH5	CHANNEL5
CHLD	CHILD
CINE	CINEMA
CLUB	TELECLUB
CMT	CMT
CNN	CNN
CSUR	ANDALUCIA
DISC	DISCOVERY
DR	DR TV
DRS	DRS
DSF	DSF
ETB1	ETB1
ETB2	ETB2
EURO	EURONEWS
EUSP	EUROSPORTS
FEMM	FEMMAN
FILM	FILM
FNET	FILMNET
FR2	France2
FR3	France3
GALA	GALAVISION
HR3	HESSEN3
INFO	INFO-KANAL
ITA1	ITALIA1
ITA7	ITALIA7
ITV	ITV
JSTV	JSTV
KA2	KA2
KAB1	KABEL1
KAN2	KANAL2
LOCA	LOCAL
M6	M6
MBC	MBR
MCM	MCM
MDR	MDR
MOVE	MOVIE
MTV	MTV
MTV3	MTV3
N3	NORD3
N-TV	N-TV
NBC	NBC SUPER
NDR3	NDR3
NED1	NED1
NED2	NED2
NED3	NED3
NEWS	
NICK	NICKELODEON
NRK	NRK
NRK2	NRK2
ODE	ODEON
ORF1	ORF1

ID*	STATION NAME
ORF2	ORF2
ORF3	ORF3
OWL3	OWL3
PREM	PREMIERE
PRO7	PRO7
RAI1	RAI1
RAI2	RAI2
RAI3	RAI3
RET4	RETE4
21	TELE21
RTBF	RTBF1 or 2
RTL	RTL
RTL2	RTL2
RTL4	RTL4
RTL5	RTL5
RTP	RTP
S4	SCHWEIZ4
SAT1	SAT1
SBS	SBS
SHOW	SHOW
SIC	SOCIEDADE
SKY	SKY CHANNEL
SKYN	SKY NEWS
SPRT	SPORT
SRTL	SUPER RTL
STAR	STAR-TV
SVT1	SVT1
SVT2	SVT2
SW3	SUEDWEST3
TCC	TCC
TELE	TELE
TEL5	TELE5
TF1	TF1
TM3	TM3
TMC	TELEMONTECARLO
TNT	TNT INT
TRT	TRT INT
TSI	TSI
TSR	TSR
TV1	BRTN TV1
TV2	BRTN TV2
TV3	TV3
TV4	TV4
TV5	TV5
TV6	TV6
TVE1	TVE1
TVE2	TVE2
TVG	TV GALICIA
TVI	TV INDEPENDENT
TVN	TV NORGE
VCR	VIDEO
VERO	VERONICA
VH-1	VH-1
VIVA	VIVA
VIV2	VIVA2
VMTV	VIDEO MUSIC
VOX	VOX
VT4	VT4
VTM	VTM
WDR1	West1
WDR3	West3
YLE1	YLE1
YLE2	YLE2
ZDF	ZDF
ZTV	ZTV

\* The "ID" abbreviation is what is shown on-screen in lieu of the station name. The "ID" abbreviation is listed in the Confirmation screen and is displayed on the TV screen when the recorder is tuned to a different station.

Turn on the TV and select the VIDEO channel (or AV mode).

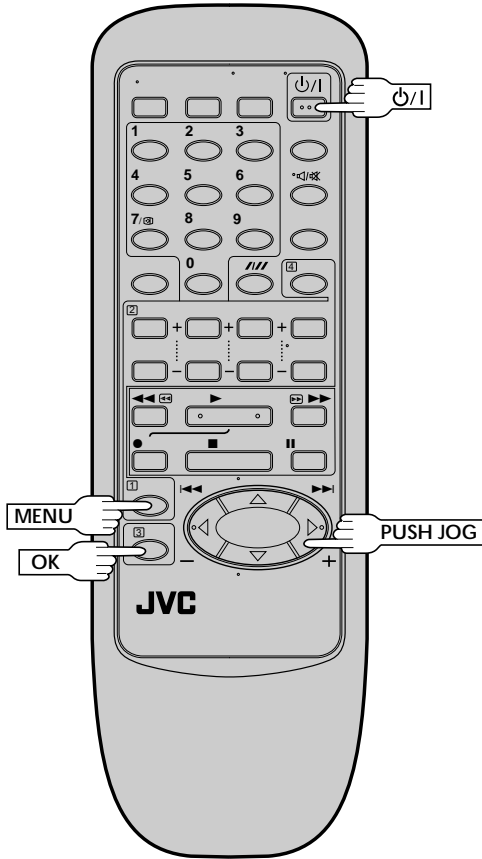

### IMPORTANT

Perform the following steps only if auto clock set has not been set correctly by Auto Set Up function (pg. 4) or Auto Channel Set (pg. 34) or if the recorder's memory backup has expired.

If you performed Auto Set Up or Auto Channel Set without ever having set the clock previously, the recorder's built-in clock is also set automatically. The Auto and Manual clock setting procedures are necessary when . . .

- a power outage of more than 3 minutes occurs.
- the tuner has been set manually.
- the user desires to set the clock slightly ahead of the actual time.
- the clock was not set even after Auto Set Up or Auto Channel Set was performed.

Whether you perform Auto or Manual clock setting, you can use the convenient Just Clock function.

### Just Clock

The Just Clock function provides accurate time keeping through automatic adjustments at regular intervals, by reading data from a PDC signal.

The Just Clock option appears in the Clock Set and Auto Clock screens, and can be set "ON" or "OFF" (the default setting is "OFF"). Press **OK** until the Just Clock setting begins blinking, then press **PUSH JOG**  $\Delta \nabla$  to change the setting.

**IMPORTANT:** If you turn off Just Clock, the accuracy of your recorder's built-in clock may be reduced, which could adversely effect timer recording. We recommend you to keep Just Clock on. In cases where the clock setting data from a PDC signal is incorrect, however, you are advised to keep Just Clock set to "OFF".

Both Auto and Manual clock setting procedures begin from step 4.

## Preparation

### 1 TURN THE RECORDER ON

Press  $\text{P}/\text{I}$ .

### 2 ACCESS MAIN MENU SCREEN

Press **MENU** twice.

### 3 ACCESS CLOCK SET SCREEN

Move the highlight bar (pointer) to "CLOCK SET" by pressing **PUSH JOG**  $\Delta \nabla$ , then press **OK**. The Clock Set screen appears.

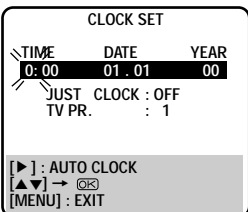
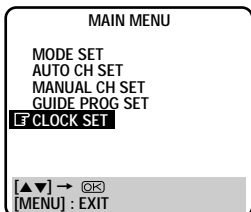

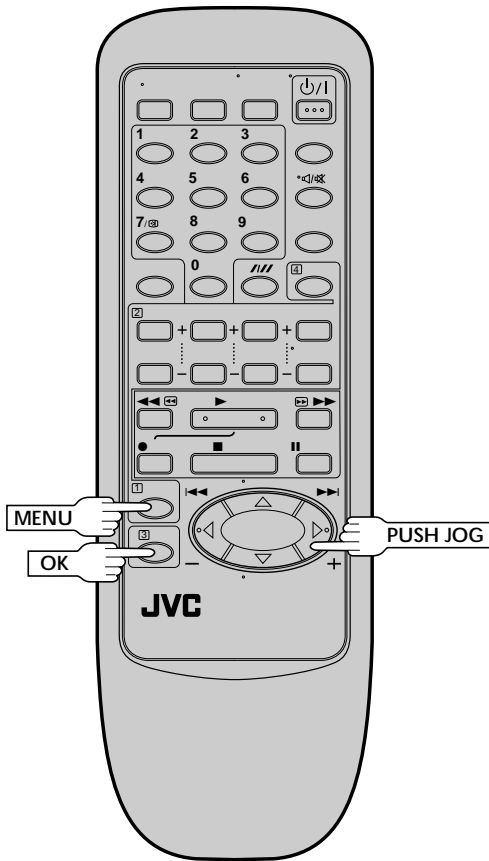

## NOTES:

- Auto Clock and Just Clock require a PDC signal, and will not operate with a VPS signal.
- Just Clock (when set to "ON") enables adjustment of the recorder's built-in clock every hour on the hour, except for 23:00, 0:00, 1:00 and 2:00.
- Just Clock is not effective when . . .
  - the recorder's power is on (unless the recorder is tuned to the same channel position selected in the Clock Set screen).
  - the recorder is in the Timer mode.
  - a difference of more than 3 minutes exists between the built-in clock's time and the actual time.
- If Just Clock is set to "ON", the recorder's clock is automatically adjusted at the start/end of Summer Time.
- Auto clock setting and Just Clock may not function properly depending on the reception condition.
- During Manual clock setting, if the day and month data are invalid (such as 31st April), the month digits are cleared automatically and the day digits begin blinking. Input the correct data.
- If, in step 4 of the Manual clock setting procedure, the year digits are automatically cleared and the day digits begin blinking, it is possible that you have input 29th February for a non-leap year. Input the correct data.

## Auto Clock Set

### 4 SET CLOCK AUTOMATICALLY

At the Clock Set screen, press **PUSH JOG**  $\triangleright$ . The Auto Clock screen appears and clock setting begins.

AUTO CLOCK  
 PLEASE WAIT  
 JUST CLOCK : OFF  
 TV. PR : 1

- If "TV PR." isn't set to the channel position on which Auto Clock data is received, "ERROR" appears, and then the screen from step 3 reappears. To set "TV PR.", press **OK** to place the pointer next to it, then cycle through the numbers by pressing **PUSH JOG**  $\Delta$   $\nabla$  until the number representing the channel position in which the station transmitting clock setting data is stored appears.

### 5 RETURN TO NORMAL SCREEN

Once clock setting is completed, press **MENU** to return to the normal screen.

## Manual Clock Set

### 4 SET DATE AND TIME

Press **PUSH JOG**  $\Delta$   $\nabla$  to set the hour, then press **OK**. The "minutes" display begins blinking. Repeat the procedure to set the minutes, day, month and year.

### 5 SET JUST CLOCK

The default setting is "OFF". Set as desired by pressing **PUSH JOG**  $\Delta$   $\nabla$ , then press **OK**.

- If you set to "OFF", you can disregard the next step as you won't be able to receive regular clock adjustments.

### 6 SET CLOCK DATA SOURCE CHANNEL POSITION

The recorder is preset to receive clock setting and adjustment data from channel position 1. Press **PUSH JOG**  $\Delta$   $\nabla$  to set the channel position to the number representing the station transmitting clock setting data, then press **OK**.

### 7 START CLOCK OPERATION

Press **MENU**.



**PLAYBACK**

---

- Q. What happens if the end of the tape is reached during playback or search?**  
**A.** The tape is automatically rewound to the beginning.  
.....
- Q. Can the video recorder indefinitely remain in the still mode?**  
**A.** No. It stops automatically after 5 minutes to protect the heads.  
.....
- Q. During search, slow, still and frame-by-frame playback, I can't hear any audio. What's the problem?**  
**A.** This is normal.  
.....
- Q. When returning from multi-speed search to normal playback, the picture is disturbed. Should I be concerned about this?**  
**A.** No, it is normal.  
.....
- Q. Noise bars appear during multi-speed search. What's the problem?**  
**A.** This is normal.  
.....
- Q. Other than preventing further recording, what effect does removing the Record Safety tab have?**  
**A.** It disables marking of index codes.  
.....
- Q. Sometimes, during Index Search, the video recorder can't find the programme I want to see. Why not?**  
**A.** There may be index codes too close together.  
.....

**RECORDING**

---

- Q. When I pause and then resume a recording, the end of the recording before the pause is overlapped by the beginning of the continuation of recording. Why does this happen?**  
**A.** This is normal. It reduces distortion at the pause and resume points.  
.....
- Q. Can the video recorder indefinitely remain in the Record-Pause mode?**  
**A.** No. The video recorder goes to its Stop mode automatically after 5 minutes to protect the heads.  
.....
- Q. What happens if the tape runs out during recording?**  
**A.** The video recorder automatically rewinds it to the beginning.  
.....

**TIMER RECORDING**

---

- Q. "O" and "⊖" remain lit on the display panel. Is there a problem?**  
**A.** No. This is a normal condition for a timer recording in progress.  
.....
- Q. Can I program the timer while I'm watching a tape or a TV broadcast?**  
**A.** You won't see the picture as it is replaced by the on-screen menu, but the audio from the program or tape you're viewing can be heard.  
.....

**ATTENTION:**

This recorder contains microcomputers. External electronic noise or interference could cause malfunctioning. In such cases, switch the recorder off and unplug the mains power cord. Then plug it in again and turn the recorder on. Take out the cassette. After checking the cassette, operate the unit as usual.

Before requesting service for a problem, use this chart and see if you can repair the trouble yourself. Small problems are often easily corrected, and this can save you the trouble of sending your video recorder off for repair.

## POWER

SYMPTOM	POSSIBLE CAUSE	CORRECTIVE ACTION
1. No power is applied to the recorder.	<ul style="list-style-type: none"> <li>The mains power cord is disconnected.</li> </ul>	Connect the mains power cord.
2. The clock is functioning properly, but the recorder cannot be powered.	<ul style="list-style-type: none"> <li>"⊖" is displayed on the display panel with Auto Timer set to "OFF".</li> </ul>	Press the <b>TIMER</b> button to turn the "⊖" indicator off.

## TAPE TRANSPORT

SYMPTOM	POSSIBLE CAUSE	CORRECTIVE ACTION
1. The tape does not run during recording.	<ul style="list-style-type: none"> <li>"□□" is displayed on the display panel.</li> </ul>	Press <b>PLAY</b> to turn the "□□" indicator off.
2. The tape stops during rewind or fast-forward.	<ul style="list-style-type: none"> <li>"M" is displayed on the display panel.</li> </ul>	Press <b>C.MEMORY</b> to deactivate the Counter Memory function and turn the "M" indicator off.
3. The tape will not rewind or fast-forward.	<ul style="list-style-type: none"> <li>The tape is already fully rewound or fast-forwarded.</li> </ul>	Check the cassette.

## PLAYBACK

SYMPTOM	POSSIBLE CAUSE	CORRECTIVE ACTION
1. The playback picture does not appear while the tape is running.	<ul style="list-style-type: none"> <li>If you're using the RF OUT connection . . . . . the TV receiver's channel selector is not set to the VIDEO channel. . . . . the recorder's VIDEO channel has not been correctly set.</li> <li>If you're using the AV connection, the TV receiver is not set to the AV mode.</li> </ul>	<p>If you are using the RF OUT connection . . . . . set the TV receiver to the VIDEO channel. (☞ pg. 8)</p> <p>. . . . . Perform "Video Channel Set" (☞ pg. 8)</p> <p>If you are using the AV connection, set the TV to its AV mode.</p>
2. Noise appears during visual search.	<ul style="list-style-type: none"> <li>This is normal.</li> </ul>	
3. Noise appears during normal playback.	<ul style="list-style-type: none"> <li>The automatic tracking mode is engaged.</li> </ul>	Try manual tracking. (☞ pg. 14)
4. Noise appears during slow-motion playback.	<ul style="list-style-type: none"> <li>The automatic tracking mode is engaged.</li> </ul>	Try manual tracking. (☞ pg. 14)
5. Noise appears during still playback.		Press <b>TV PROG.+</b> or <b>-</b> a few times to remove the noise bars from the screen.
6. (HR-J648E/EH only) Breaks are noticeable in Hi-Fi soundtrack	<ul style="list-style-type: none"> <li>Automatic tracking is engaged.</li> </ul>	Engage and adjust tracking manually. (☞ pg. 14)
7. The playback picture is blurred or interrupted while TV broadcasts are clear.	<ul style="list-style-type: none"> <li>The video heads may be dirty.</li> </ul>	Consult your JVC dealer.

## RECORDING

SYMPTOM	POSSIBLE CAUSE	CORRECTIVE ACTION
1. Recording cannot be started.	<ul style="list-style-type: none"> <li>There is no cassette loaded, or the cassette loaded has had its Record Safety tab removed.</li> </ul>	Insert a cassette, or using adhesive tape, reseal the slot where the tab was removed.
2. TV broadcasts cannot be recorded.	<ul style="list-style-type: none"> <li>"AU" has been selected as the input mode.</li> </ul>	Set to the desired channel.
3. Tape-to-tape editing is not possible.	<ul style="list-style-type: none"> <li>The source (another video recorder, camcorder) has not been properly connected.</li> <li>All necessary power switches have not been turned on.</li> <li>The input mode is not correct.</li> </ul>	<p>Confirm that the source is properly connected.</p> <p>Confirm that all units' power switches are turned on.</p> <p>Set the input mode to "AU".</p>

4. Camcorder recording is not possible.

- The camcorder has not been properly connected.
- The input mode is not correct.

Confirm that the camcorder is properly connected.  
Set the input mode to "AU".

## TIMER RECORDING

SYMPTOM	POSSIBLE CAUSE	CORRECTIVE ACTION
1. Timer recording won't work.	<ul style="list-style-type: none"> <li>● The clock and/or the timer have been set incorrectly.</li> <li>● The timer is not engaged.</li> </ul>	Re-perform the clock and/or timer settings. Press <b>TIMER</b> and confirm that "⊖" is displayed on the display panel.
2. On-screen timer programming is not possible.	<ul style="list-style-type: none"> <li>● Timer recording is in progress.</li> </ul>	Timer programming can't be performed while a timer recording is in progress. Wait until it finishes.
3. "⊖" and "⊖" on the display panel won't stop blinking.	<ul style="list-style-type: none"> <li>● The timer is engaged but there's no cassette loaded.</li> </ul>	Load a cassette with the Record Safety tab intact, or cover the hole using adhesive tape.
4. The cassette is automatically ejected, and "⊖" and "⊖" on the display panel won't stop blinking.	<ul style="list-style-type: none"> <li>● The loaded cassette has had its Record Safety tab removed.</li> </ul>	Remove the cassette and cover the hole with adhesive tape, or insert a cassette with the Record Safety tab intact.
5. "⊖" blinks for 10 seconds and the Timer mode is disengaged.	<ul style="list-style-type: none"> <li>● <b>TIMER</b> has been pressed when there are no programs in memory, or the timer record information has been programmed incorrectly.</li> </ul>	Check the programmed data and re-program as necessary, then press <b>TIMER</b> again.
6. The cassette is automatically ejected, the power shuts off and "⊖" and "⊖" won't stop blinking.	<ul style="list-style-type: none"> <li>● The end of the tape was reached during timer recording.</li> </ul>	The programme may not have been recorded in its entirety. Next time make sure you have enough time on the tape to record the entire programme.
7. SHOWVIEW does not timer-record properly.	<ul style="list-style-type: none"> <li>● The recorder's channel positions have been set incorrectly.</li> </ul>	Refer to "Guide Program Number Set" and re-perform the procedure (Ⓛ pg. 10).

## OTHER PROBLEMS

SYMPTOM	POSSIBLE CAUSE	CORRECTIVE ACTION
1. Whistling or howling is heard from the TV during camcorder recording.	<ul style="list-style-type: none"> <li>● The camcorder's microphone is too close to the TV.</li> <li>● The TV's volume is too high.</li> </ul>	Position the camcorder so its microphone is away from the TV. Turn the TV's volume down.
2. When scanning channels, some of them are skipped over.	<ul style="list-style-type: none"> <li>● Those channels have been designated to be skipped.</li> </ul>	If you need the skipped channels, restore them (Ⓛ pg. 36).
3. The channel cannot be changed.	<ul style="list-style-type: none"> <li>● Recording is in progress.</li> </ul>	Press <b>PAUSE</b> to pause the recording, change channels, then press <b>PLAY</b> to resume recording.
4. Channel settings that were made manually seem to have changed or disappeared.	<ul style="list-style-type: none"> <li>● After the manual settings were made, Auto Channel Set was performed.</li> </ul>	Perform manual setting again.
5. No channels are stored in the recorder's memory.	<ul style="list-style-type: none"> <li>● The TV aerial cable was not connected to the recorder when Auto Set Up was performed.</li> </ul>	Connect the TV aerial cable to the recorder properly and turn off the recorder power once, then turn the recorder power back on again. The recorder will try Auto Set Up again (Ⓛ pg. 4).

## FRONT VIEW

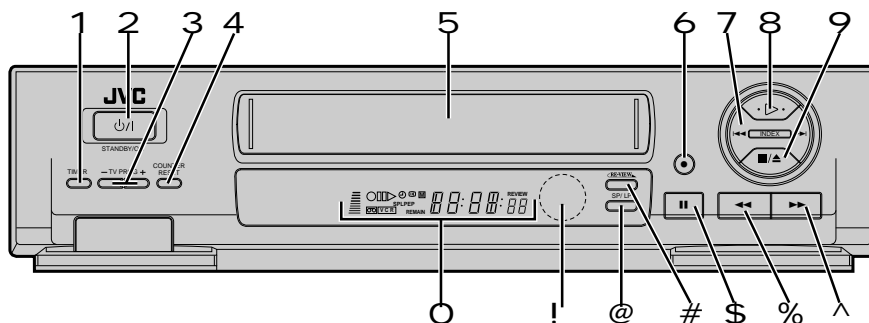

- 1 TIMER Button ☞ pg. 25, 27
- 2 STANDBY/ON  $\phi$ /I Button ☞ pg. 4
- 3 TV PROG. +/- Buttons ☞ pg. 17
- 4 COUNTER RESET Button ☞ pg. 21
- 5 Cassette Loading Slot
- 6 RECORD Button ☞ pg. 17
- 7 INDEX Button ☞ pg. 15
- 8 PLAY Button ☞ pg. 12
- 9 STOP/EJECT Button ☞ pg. 12

- O Display Panel ☞ pg. 45
- ! Infrared Beam Receiving Window
- @ SP/LP Button ☞ pg. 17 (HR-J648E/J648EH/J448E)  
DISPLAY Button ☞ pg. 21 (HR-J248E)
- # REVIEW Button ☞ pg. 15
- \$ PAUSE Button ☞ pg. 13
- % Rewind [REW] Button ☞ pg. 12
- ^ Fast Forward [FF] Button ☞ pg. 12

## REAR VIEW [J648E/EH]

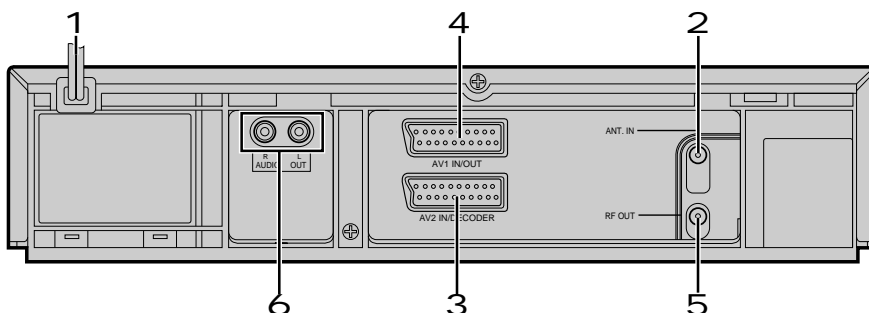

## REAR VIEW [J448E/J248E]

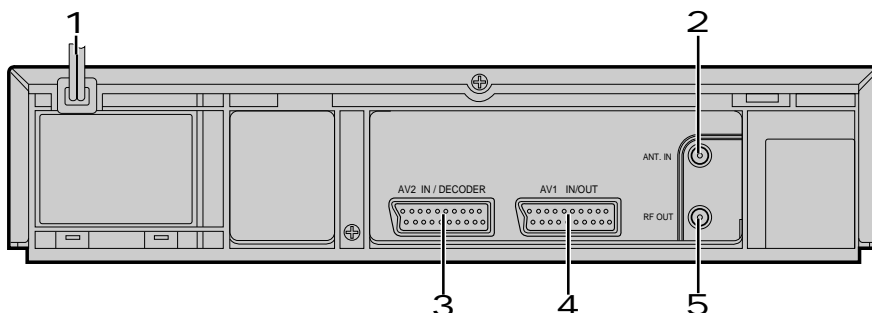

- 1 Mains Power Cord ☞ pg. 3
- 2 ANT. IN Connector ☞ pg. 3
- 3 AV2 IN/DECODER Connector ☞ pg. 30, 33
- 4 AV1 IN/OUT Connector ☞ pg. 3, 30

- 5 RF OUT Connector ☞ pg. 3
- 6 AUDIO OUT (L/R) Connectors ☞ pg. 3  
(HR-J648E/EH only)

## DISPLAY PANEL

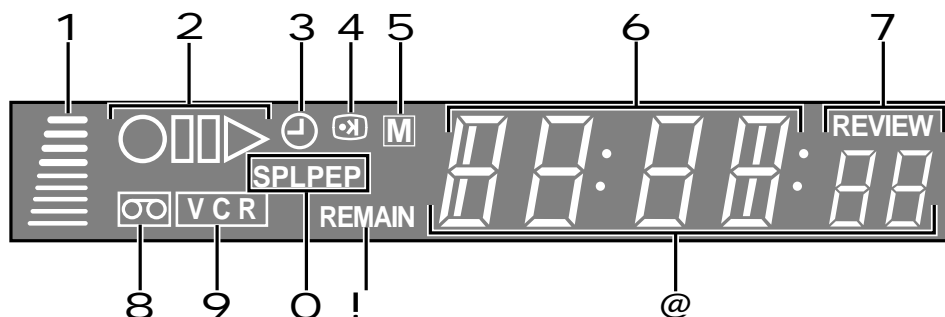

- 1 B.E.S.T. Picture System Display ☞ pg. 18
- 2 Symbolic Mode Indicators

PLAY: FF/REW VARIABLE SHUTTLE SEARCH:	▶	STILL: SLOW:	▢▢▶
		RECORD:	○
		RECORD PAUSE:	○▢▢

- 3 "Timer" Indicator ☞ pg. 25, 27
- 4 PDC/VPS Indicator ☞ pg. 29

- 5 Counter Memory Indicator ☞ pg. 16
- 6 Channel\*/Mode Display ☞ pg. 17  
\* Channel position 1 will be displayed as "CH 1".  
Clock Display ☞ pg. 5, 39
- 7 Instant REVIEW Indicator ☞ pg. 15
- 8 "Cassette Loaded" Mark
- 9 VCR Indicator ☞ pg. 21
- 10 Tape Speed Indicators ☞ pg. 17
- ! Tape Remaining Time Indicator ☞ pg. 21
- @ Counter/Remain Display ☞ pg. 21

## REMOTE CONTROL

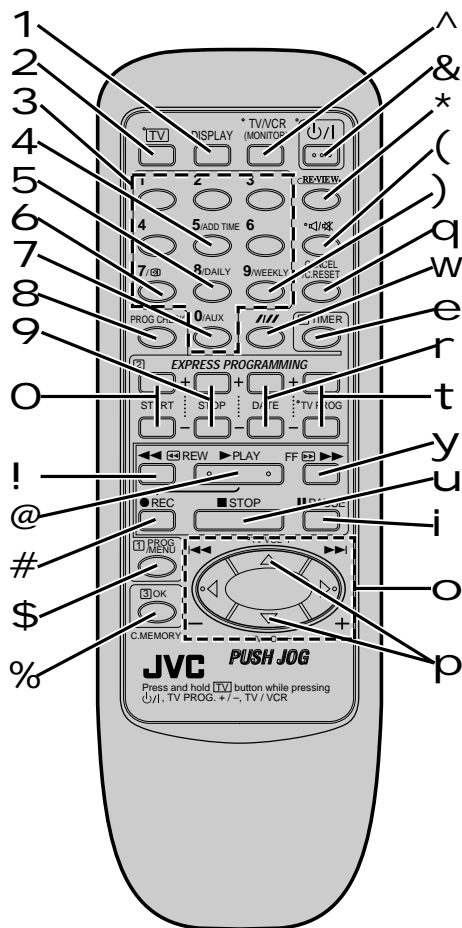

- 1 DISPLAY Button ☞ pg. 21
- 2 TV Button (See below)
- 3 NUMBER Keys ☞ pg. 17, 24
- 4 ADD TIME Button ☞ pg. 25
- 5 DAILY Button ☞ pg. 25, 27
- 6 (PDC/VPS) Button ☞ pg. 24, 27
- 7 AUX Button ☞ pg. 30
- 8 PROG. CHECK Button ☞ pg. 28
- 9 STOP +/- Button ☞ pg. 26
- ! Rewind [REW] Button ☞ pg. 12
- @ Play Button ☞ pg. 12
- # Record Button ☞ pg. 17
- \$ PROG./MENU Button ☞ pg. 7, 24
- % OK Button ☞ pg. 7
- C. MEMORY Button ☞ pg. 16
- ^ TV/VCR Button ☞ pg. 21
- & STANDBY/ON  $\phi$ /I Button ☞ pg. 4
- \* REVIEW Button ☞ pg. 15
- ( AUDIO MONITOR Button ☞ pg. 16
- ) WEEKLY Button ☞ pg. 25, 27
- q CANCEL Button ☞ pg. 11
- C. RESET Button ☞ pg. 21
- w SP/LP Button ☞ pg. 17
- Auto Tracking Button ☞ pg. 14
- e TIMER Button ☞ pg. 25, 27
- r DATE +/- Button ☞ pg. 26
- t TV PROG. +/- Button ☞ pg. 17
- y Fast Forward [FF] Button ☞ pg. 12
- u Stop Button ☞ pg. 12
- i Pause Button ☞ pg. 13
- PUSH JOG  $\Delta$   $\nabla$   $\triangleleft$   $\triangleright$  Button ☞ pg. 7
- PUSH JOG  $\triangleleft$   $\triangleright$  Button ☞ pg. 13, 15
- p TV VOL  $\Delta$   $\nabla$  Button (See below)

## Installing Batteries

- 1 Open the battery compartment cover.
- 2 Insert 2 "R6"-size batteries (provided) in the correct directions.
- 3 Replace the cover.

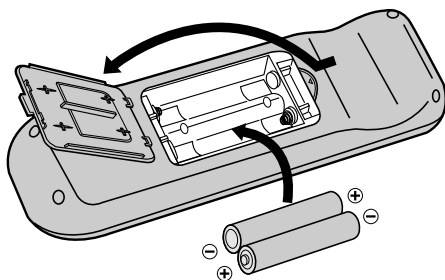

## How To Use

The remote control can operate most of your video recorder's functions, as well as basic functions of JVC TV sets. (See below)

- Point the remote control toward the sensor window.
- The maximum operating distance of the remote control is about 8 m.

## Operating JVC TVs

To operate your TV, while holding down **TV**, press the corresponding button: **STANDBY/ON**  $\phi$ /I, **TV/VCR**, **TV PROG. +/-**,  $\triangleleft$ / $\triangleright$  (TV Mute). **TV VOL. +/-** can be used without holding down **TV**.

## NOTES:

- Depending on the type of JVC TV, there may be cases where some or all functions cannot be operated using the remote control.
- If the remote control doesn't work properly, remove its batteries, wait a short time, replace the batteries and then try again.

## GENERAL

Power requirement	: AC 220 – 240 V~, 50/60 Hz
Power consumption	: 24 W (HR-J648E/EH) : 20 W (HR-J448E/J248E)
Temperature	
Operating	: 5°C to 40°C
Storage	: -20°C to 60°C
Operating position	: Horizontal only
Dimensions (WxHxD)	: 400 x 94 x 340 mm
Weight	: 4.3 kg
Format	: VHS PAL standard
Maximum recording time	
(SP)	: 240 min. with E-240 video cassette
(LP) [HR-J648E/J648EH/J448E only]	: 480 min. with E-240 video cassette

## VIDEO/AUDIO

Signal system	: PAL-type colour signal and CCIR monochrome signal, 625 lines 50 fields
Recording system	: DA4 (Double Azimuth) head helical scan system (HR-J648E/EH, J448E) Rotary two-head helical scan system (HR-J248E)
Signal-to-noise ratio	: 45 dB
Horizontal resolution	: 250 lines
Frequency range	: 70 Hz to 10,000 Hz (Normal audio) 20 Hz to 20,000 Hz (Hi-Fi audio) (HR-J648E/EH only)
Input/Output	: 21-pin scart connectors : IN/ OUT x 1, IN/DECODER x 1 RCA connectors: AUDIO OUT x 1 (HR-J648E/EH only)

## TUNER/TIMER

TV channel storage capacity	: 99 positions (+AUX position "AU")
Tuning system	: Frequency synthesized tuner
Channel coverage	: VHF 47 – 89/104 – 300/ 302 – 470MHz UHF 470 – 862MHz
Aerial output	: UHF channels 22 – 69 (Adjustable)
Memory backup time	: Approx. 3 min.

## ACCESSORIES

Provided accessories	: RF cable, Infrared remote control unit, "R6" battery x 2
----------------------	------------------------------------------------------------------

*Specifications shown are for SP mode unless otherwise specified.*

*E. & O.E. Design and specifications subject to change without notice.*

## Auto Set Up - referring to the display panel

The Auto Set Up function sets the tuner channels, clock and Guide Program numbers automatically.

### BEFORE YOU START PLEASE MAKE SURE THAT:

- The TV aerial cable is connected to the ANT.IN jack on the rear panel of the video recorder.
- The video recorder's mains power cord is connected to a mains outlet.
- The video recorder is turned off.
- Load batteries into the remote control.

**1** Press  $\text{O/I}$  (recorder/remote).



**2** Press **PUSH JOG**  $\Delta \nabla$  (remote) to select the international telephone country code.  
(Ex.) DEUTSCHLAND is selected.



- If you have selected a country code other than 32 (BELGIUM) or 41 (SUISSE), go to step 3.

#### International Telephone Country Code

SUOMI	: 358	SUISSE	: 41
PORTUGAL	: 351	ITALIA	: 39
DEUTSCHLAND	: 49	ESPAÑA	: 34
NORGE	: 47	BELGIUM	: 32
SVERIGE	: 46	NEDERLAND	: 31
DANMARK	: 45	GREECE	: 30
ÖSTERREICH	: 43	OTHERS	: - -

- If you have selected 32 (BELGIUM) or 41 (SUISSE), press **OK** (remote) and select the language code by pressing **PUSH JOG**  $\Delta \nabla$  (remote), then go to step 3.

(Ex.) FRANCAIS is selected for BELGIUM



International Telephone  
Country Code

Language Code

#### Language Code

ENGLISH	: 01	NEDERLANDS	: 06
DEUTSCH	: 02	SVENSKA	: 07
FRANCAIS	: 03	NORSK	: 08
ITALIANO	: 04	SUOMI	: 09
CASTELLANO	: 05	DANSK	: 10

**3** Press **OK** (remote). Do NOT press any button on the video recorder or remote control until the current time appears.



During Auto Set Up



Auto Set Up completed

- If "CH1" or "- -: - -" appears on the display panel, see page 5 of the instructions.

\*Once you have performed Auto Set Up, even if the recorder's memory backup has expired, the recorder will not perform Auto Set Up again.

FOR MORE INFORMATION SEE INSTRUCTIONS/P4

# JVC

VICTOR COMPANY OF JAPAN, LIMITED